



ALL-METAL TOASTER

RECIPES AND USER GUIDE



READ BEFORE USE

USA: 1-800-851-8900 Canada: 1-800-267-2826

840130300

Dear Toaster Owner,

Congratulations on your purchase. The Hamilton Beach® Eclectrics™ Collection adds a modern twist to those dependable, all-metal appliances you remember from yesteryear.

Owning a Hamilton Beach® is like owning a piece of history. In 1904, Louis Hamilton and Chester Beach teamed up to bring motorized appliances like vacuums, sewing machines, and mixers into American households. In honor of their 100-year legacy, we've combined the "built to last" metal construction of the past with the styling of today to bring lasting quality and style to your kitchen.

As you use your all-metal appliance, think about the history that came before it. Enjoy the confidence you have in a product backed by years of experience and a 3-year warranty. But most of all, fill your home with the delicious aroma of homemade recipes that your appliance helps you create!

I hope you enjoy your Hamilton Beach® Eclectrics™ appliance for many years to come.

Sincerely,



Michael J. Morecroft
President and Chief Executive Officer
Hamilton Beach/Proctor-Silex, Inc.

Table of Contents

| | | | |
|--|---|-----------------------------------|------|
| Warranty Information | 3 | Recipes | 8-12 |
| Important Safeguards | 4 | <i>Cream Cheese Spreads</i> | 8 |
| Toasting Guide | 5 | <i>Flavored Butters</i> | 9 |
| Assistance and Service Information | 5 | <i>Sandwiches and Pizza</i> | 10 |
| Parts and Features..... | 6 | <i>Bread</i> | 11 |
| Using Your Toaster | 7 | | |
| Tips and Troubleshooting | 7 | | |
| Cleaning Your Toaster | 8 | | |

Warranty Information

Standard Three Year Warranty

Congratulations! You now own one of the finest toasters. We're so confident in the quality and craftsmanship of your new toaster that we're backing your purchase with a No-Hassle 3-Year Replacement Warranty. If your toaster malfunctions within 3 years of purchase, we will deliver a brand new replacement toaster to your door and remove the old unit at no cost to you. Here's how it works:

| Warranty Term | To fulfill the warranty: | Hamilton Beach® will | Hamilton Beach® will not pay for |
|---|--|---|---|
| <p>Three years from date of original purchase for toasters operated in the continental United States, Alaska, and Hawaii.</p> <p>This warranty applies only to the original consumer purchaser.</p> | <ol style="list-style-type: none"> 1. Follow the instructions in this Manual. Refer to Tips & Troubleshooting sections if you have any problems operating the unit. If you have any questions, call one of the Customer Service numbers on page 5. 2. Keep your proof of purchase. If the unit malfunctions within 3 years of purchase, call one of the Customer Service numbers on page 5. | <ol style="list-style-type: none"> 1. Send a pre-paid shipping label so you can send us the unit. 2. Ship a brand new replacement unit to your address. | <p>Product failures arising from abuse, misuse, neglect, use for commercial purposes, or use contrary to this Manual.</p> <p>THIS WARRANTY IS IN LIEU OF ANY OTHER WARRANTY, EXPRESS OR IMPLIED, WRITTEN OR ORAL, INCLUDING ANY WARRANTY OF MERCHANTABILITY OR FITNESS FOR A PARTICULAR PURPOSE. ANY LIABILITY IS EXPRESSLY LIMITED TO THE PURCHASE PRICE PAID. ALL CLAIMS FOR SPECIAL, INCIDENTAL OR CONSEQUENTIAL DAMAGES ARE EXPRESSLY EXCLUDED.</p> |

WARNING



Fire Hazard

- Do not operate while unattended.
- Do not use with food that has been spread with butter, jelly, frosting, etc.
- Do not use with rice cakes, fried foods, frozen prepared foods or non-bread items.
- Do not use with toaster pastries. Always cook toaster pastries in a toaster oven broiler.
- Do not cover or use near curtains, walls, cabinets, paper or plastic products, cloth towels, etc.
- Close supervision is necessary when used by or near children.
- Always unplug toaster when not in use.
- Failure to follow these instructions can result in death or fire.

IMPORTANT SAFEGUARDS

1. Read all instructions.
2. Do not operate toaster while unattended.
3. Close supervision is necessary when any appliance is used by or near children.
4. Do not attempt to dislodge food when toaster is plugged in.
5. To protect against electrical shock, do not immerse cord, plug, or toaster in water or other liquid.
6. Unplug from outlet when not in use and before cleaning. Allow to cool before putting on or taking off parts, or moving toaster.
7. Do not operate toaster with a damaged cord or plug or after toaster malfunctions or has been damaged in any manner. Call our toll-free customer service number for information on examination, repair or adjustment.
8. Oversized foods, metal foil packages, or utensils must not be inserted in a toaster as they may involve a risk of fire or electric shock.
9. Do not clean with metal scouring pads. Pieces can break off pad and touch electrical parts resulting in risk of electrical shock.
10. A fire may occur if toaster is covered or touching flammable material, including curtains, draperies, walls, overhead cabinets, paper or plastic products, cloth towels, and the like, when in operation.
11. Do not operate toaster in an enclosed space, such as an appliance cabinet, caddy, garage or other storage area.
12. Do not cook, warm, or toast rice cakes, fried foods, non-bread items or toaster pastries. Toaster pastries should be heated in a toaster oven broiler. Do not heat any food product that has been spread or iced with margarine, butter, jelly, frosting, syrup, or other spread. Follow Toasting Guide.
13. Failure to clean crumb tray may result in a fire hazard.
14. Do not place on or near a hot gas or electric burner, or in a heated oven.
15. Do not touch hot surfaces. Use handles or knobs.
16. The use of accessory attachments not recommended by Hamilton Beach/Proctor-Silex, Inc. may cause injuries.
17. Do not let cord hang over edge of table or counter, or touch hot surfaces.
18. Before unplugging toaster, make sure bread lifter is in "up" position.
19. Do not use outdoors.
20. Do not use toaster for other than intended use.
21. This product is for household use only.

SAVE THESE INSTRUCTIONS

Other Consumer Safety Information

To avoid a circuit overload, do not operate another high wattage appliance on the same circuit.

This appliance is equipped with a polarized plug. This type of plug has one blade wider than the other. The plug will fit into an electrical outlet only one way. This is a safety feature intended to help reduce the risk of electrical shock. If you are unable to insert the plug into the outlet, try reversing the plug. If the plug should still fail to fit, contact a qualified electrician to replace the obsolete outlet. Do not attempt to defeat the safety purpose of the polarized plug by modifying the plug in any way.

The length of the cord used on this appliance was selected to reduce the hazards of becoming tangled in, or tripping over, a longer cord. If a longer cord is necessary, an approved extension cord may be used. The electrical rating of the extension cord must be equal to or greater than the rating of the toaster. Care must be taken to arrange the extension cord so that it will not drape over the countertop or tabletop where it can be pulled on by children or accidentally tripped over.

Toasting Guide

| FOOD | Shade Setting | Optional Setting* |
|--|-------------------------|-------------------|
| Regular bread | Med. Light to Med. Dark | Toast |
| English muffins | Med. Dark | Bagel |
| Bagels | Med. to Dark | Bagel |
| Frozen bread or buns | Med. Dark | Toast |
| Frozen waffles or pastries | Light | Toast |
| Toaster pastries (such as Pop Tarts®) Do not heat in toaster – use toaster oven broiler. If you must use toaster – ALWAYS set to lowest shade setting, NEVER heat cracked, broken or warped pastries, and NEVER leave unattended. | | |

*on selected models

® Pop Tart is a registered trademark of the Kellogg Co.

Assistance and Service

Before Calling for Assistance

Please read before calling:

- The toaster may warm up during use. This is normal.
- The toaster may emit an odor, especially when new.

If your toaster should malfunction or fail to operate, please check the following:

- Is the toaster plugged in?
- Is the fuse in the circuit to the toaster in working order? If you have a circuit breaker box, be sure the circuit is closed.
- If the problem is not due to one of the items mentioned above, see Customer Service Information.
- DO NOT return the toaster to the retailer as they do not provide service.

Customer Service Information

If you have a question about your toaster, call our toll-free customer service number. Before calling, please note the model, type, and series numbers and fill in that information below. These numbers can be found on the bottom of your mixer. This information will help us answer your question much more quickly.

MODEL: _____ **TYPE :** _____ **SERIES:** _____

CUSTOMER SERVICE NUMBERS

In the U.S. 1-800-851-8900

In Canada 1-800-267-2826

hamiltonbeach.com

KEEP THESE NUMBERS FOR FUTURE REFERENCE!

Parts and Features

1. Food Slots with Guides

2. Bread Lifter – Push down bread lifter to start toaster. The bread lifter may be lifted up to stop toasting during a cycle.

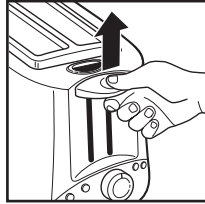

3. Shade Selector – The shade selector ranges from light to dark. Adjust to desired setting before using.

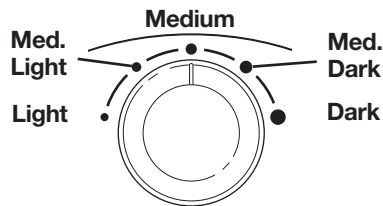

4. Programming Buttons

ON•Cancel – This light will illuminate when the toaster is on. To cancel or end a cycle, press the On/Cancel button. The cycle will stop and the light will go out.

Bagel – Use to toast only one side of a cut bagel. Load toaster with cut side of the bagel facing out, as the center heating element is turned off during this cycle. To use: press the Bagel button after the toast cycle has started.

Defrost – Use only on frozen foods that were made to be placed in a toaster. This feature allows additional time for the food to thaw and heat through. To use: press the Defrost button after the toast cycle has started.

Reheat – Use to warm food that has cooled. This function starts a short 30 to 50 second toast cycle. The Shade Selector setting does not affect the Reheat time. To use: press the Reheat button after the toast cycle has started.

To combine programs is easy. For example, to toast a frozen bagel:

- Load bagel in toaster with cut sides facing out.
- Choose desired Shade Selector setting.
- Push down the Bread Lifter to start the toasting cycle.
- Press Bagel button, then press Defrost.

5. Slide-Out Crumb Tray (located on back of toaster – see page 8 for more information).

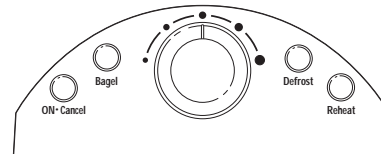
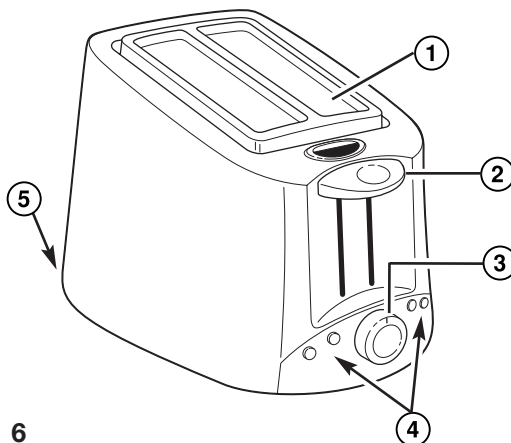

Programming Buttons and Shade Selector

Using Your Toaster

1. Plug toaster into electrical outlet.
2. Place bread or bagel in slots. If toasting bagels or English muffins, place in slots with cut sides facing outside wall of toaster. Select toast shade and press down bread lifter.
3. At the end of toasting cycle, bread will pop up automatically.
NOTE: The bread lifter will not latch down unless the toaster is plugged in.
4. To stop the toasting cycle sooner, lift up bread lifter or push the Cancel button.

Tips and Troubleshooting

- Toasting is affected by the **temperature of the bread**. Room temperature bread may toast to a medium color on Medium. The same type of bread that has been refrigerated may require setting Medium Dark, and if frozen, Dark.
- The moisture content will also affect toasting. Fresh **bagels**, made locally, will have a higher moisture content than bagels purchased in the bread section of the supermarket. The bagel setting extends toasting time to allow most bagels to toast in one cycle. Fresh bagels made locally may require two toasting cycles.
- Dark is the darkest shade of toast color. If a darker shade is desired, reset at Medium, watch closely and toast for a second cycle.
- Because of the irregular surface of **English muffins**, they may require more than one toasting cycle. After toasting for one cycle on Medium Dark, if a darker shade is desired, adjust shade selector to setting Light or Medium Light and toast for a second cycle. Watch closely to avoid overbrowning. English muffins cut with a knife toast more evenly than English muffins split with a fork.
- To remove food that becomes lodged in food slots, disconnect from outlet and allow toaster to cool. Turn toaster upside down and shake. Do not use fork or other utensil that could damage heating element or result in risk of fire or electrical shock.
- When toasting a single slice, you may notice variations in bread color from side to side.

Shock-Resistant Concealed Elements

A mica shield protects and conceals the heating elements inside each slot, reducing risk of shock due to accidental contact with a metal utensil. Therefore, the heating elements are not visible and will not glow red.

Cleaning Your Toaster

NOTE: If the toaster is used daily, the crumb tray should be cleaned weekly.

1. Unplug toaster and let cool.
2. Slide out crumb tray, discard crumbs and wipe tray with clean cloth. Replace crumb tray.
3. Wipe outside of toaster with a damp cloth. Do not use abrasive cleansers that may scratch the surface of the toaster.

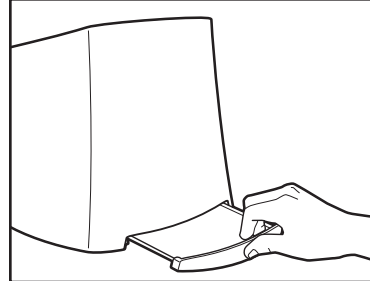

Cream Cheese Spreads

Mix cream cheese and the ingredients of one of the variations below to spread on toasted bagels or bread for a delicious breakfast or quick snack!

Strawberry Cream Cheese

3 ounce package cream cheese, softened
2 tablespoons strawberry preserves

Italian Cream Cheese

4 ounces cream cheese, softened
1 tablespoon milk
¼ cup Parmesan cheese, grated
½ teaspoon Italian seasoning

Mexican Cream Cheese

4 ounces cream cheese, softened
1 tablespoon milk
½ cup Colby and Monterey Jack cheese, shredded
½ teaspoon chili powder
½ teaspoon cilantro, optional

Jalapeño Cream Cheese

3 ounce package cream cheese, softened
2 tablespoons jalapeño jelly

Flavored Butters

Orange Honey Butter

1 cup unsalted butter (2 sticks), softened
½ tablespoon honey
½ teaspoon orange zest

Whip butter with electric mixer on HIGH speed until light and fluffy. Mix in honey and orange zest. Store covered in refrigerator. **Makes 8 servings.**

Italian Butter

1 cup unsalted butter,
softened
1 tablespoon garlic, minced
¼ cup Parmesan cheese, grated
1 teaspoon garlic salt

Beat softened butter with electric mixer on MEDIUM speed until light and fluffy. Combine garlic, Parmesan cheese, garlic salt, Italian seasoning, pepper and paprika. Mix on low setting until smooth. Spread on bread or crackers. Store covered in the refrigerator. **Makes 8 servings.**

Pizza Butter

1 cup unsalted butter,
softened
1 6 ounce can tomato paste
1 cup Parmesan cheese, grated

Beat softened butter with electric mixer on MEDIUM speed until light and fluffy. Add tomato paste, Parmesan cheese, garlic salt, oregano, and parsley; mix on medium speed until smooth. Spread on bread or crackers. Store covered in the refrigerator. **Makes 8 servings.**

Cinnamon Butter

1 cup unsalted butter, softened
2 tablespoons confectioners sugar

Beat softened butter with electric mixer on on HIGH speed until light and fluffy. Reduce mixer to low speed, add sugar, cinnamon, and nutmeg and whip until smooth and creamy. The perfect addition to pancakes, toast, or biscuits. Store covered in the refrigerator. **Makes 8 servings.**

Honey Butter

1 cup unsalted butter, softened
½ cup honey

Beat softened butter with electric mixer on on HIGH speed until light and fluffy. Reduce mixer to low speed, add honey and whip until smooth. The perfect addition to pancakes, toast, or biscuits. Store covered in the refrigerator. **Makes 8 servings.**

Sandwiches and Pizza

Zesty Chicken Sandwich

2 ½-inch slices Whole Wheat Bread (see page 11)
¼ pound chicken breast strips, cooked
1 tablespoon Italian Butter (see page 9)
¼ cup spinach
2 slices tomato
1 slice provolone cheese

Toast 2 slices of bread. Place chicken, butter, spinach, tomato, and cheese on one slice of toasted bread. Cover with remaining slice of toasted bread. **Makes 1 sandwich.**

Hero Sandwich

2 ½-inch slices Whole Wheat Bread (see page 11)
1 ounce deli ham
1 ounce deli salami
1 ounce deli turkey
1 tablespoon Italian Cream Cheese (see page 8)
2 green pepper rings
2 slices tomato

Toast 2 slices of bread. Place ham, salami, turkey, cream cheese, pepper rings and tomato on one slice of toasted bread. Cover with remaining slice of toasted bread. **Makes 1 sandwich.**

5 Minute Pizza

English muffins, split in half and slightly toasted
Pizza or spaghetti sauce
Grated mozzarella cheese
Pepperoni slices

Preheat oven to 450°F. Place muffin halves on baking pan cut side up. Spread some sauce on top of each muffin. Sprinkle with cheese and top with pepperoni. Place pan in oven and bake for about 5 minutes or until cheese melts.

Bread

100% Whole Wheat Bread

*Use mixer equipped with dough hooks.

| | |
|-------------------------------|--------------------------------|
| 1½ teaspoons active dry yeast | ½ teaspoon salt |
| 1 cup warm water | 1 egg |
| 5 tablespoons vegetable oil | 3 to 3½ cups whole wheat flour |
| 5 tablespoons honey | |

In a large bowl sprinkle yeast over water. Let stand 5 to 10 minutes or until foamy. Stir to mix, then add oil, honey, salt, and egg. Mix. Add 2 cups of the flour and mix for about 1 minute. Let stand about 20 minutes until bubbly and starting to rise. Add 1 more cup flour and mix.* Add enough of the remaining flour until dough forms a smooth ball that is slightly sticky to the touch.

Place dough in large, greased bowl. Cover and let rise 30 minutes or until double in size. Punch dough down and let rise 1 hour. Punch down. Shape into loaf. Place into 9x5 inch greased loaf pan and let rise until double in size, about 30 minutes. Bake at 400°F for 30 minutes.

Substitution: For this whole wheat bread, do not substitute all-purpose flour for any of the whole wheat flour.

Success Tip!

To shape loaves, roll out the dough to a rectangle, with the shorter side being slightly longer than the length of the pan. Starting at the shorter end, roll up the dough. Tuck the end under and place in the greased loaf pan.

Basic White Bread

*Use mixer equipped with dough hooks.

| | |
|---|--------------------------------|
| 1½ teaspoons active dry yeast | 2 tablespoons sugar |
| 1¼ cups warm water | 1 teaspoons salt |
| 1½ tablespoons butter or margarine, melted | 3 to 3½ cups all-purpose flour |

In a large mixing bowl, combine yeast and ¼ cup warm water. Stir until dissolved. Add remaining warm water, butter, sugar and salt. Stir until mixed. Add 3 cups of flour and mix* until blended. Add enough of the remaining flour until dough forms a smooth ball that is slightly sticky to the touch.

Place dough in large, greased bowl. Cover and let rise until double in size, about 1 hour. Punch dough down and shape into loaf. Place loaf into 9x5-inch greased loaf pan and let rise until double in size, about an hour. Bake at 400°F for 30 minutes.

Success Tip!

Warm water for dissolving dry yeast should be between 105°F and 115°F. If a thermometer isn't available, run hot water over your wrist. It should feel very warm, but not uncomfortably hot.

Bread

Onion Herb Bread

*Use mixer equipped with dough hooks.

| | |
|-----------------------------------|-------------------------------|
| 1½ teaspoons active dry yeast | 2 tablespoons sugar |
| ¼ cup warm water | ½ teaspoon salt |
| 1 tablespoon vegetable oil | ¼ teaspoon dried dill weed |
| ¼ cup finely chopped onion | ⅛ teaspoon ground sage |
| ¾ cup milk | 6 tablespoons yellow cornmeal |
| 1 tablespoon dried parsley flakes | 2 to 2½ cups bread flour |

In small bowl dissolve yeast in warm water. In small pan, saute onion in oil until tender. In large mixing bowl combine onion, milk, parsley, sugar, salt, dillweed, sage, and yeast. Stir to mix. Add cornmeal and 2 cups of the flour. Mix on Speed 5 or 6. Add enough of the remaining flour until dough forms a smooth ball that is slightly sticky to the touch. Place dough in large, greased bowl. Cover and let rise until double in size.

Punch down dough and shape into loaf. Place into 9x5 inch greased loaf pan and let rise until double in size about 40 minutes or until double in size. Bake in 400°F oven for 30 minutes.

Substitution: If fresh dill weed is on hand, 1 tablespoon of chopped, fresh dill weed can be used instead of ½ teaspoon of dried dill weed.

Success Tip!

Bread dough rises best at a temperature between 75°F and 85°F. If the kitchen is cold, place the bowl of covered dough on a rack in the oven. Place a bowl of hot water on a rack below. Do not turn on the oven during rising.

Honey Wheat Bread

*Use mixer equipped with dough hooks

| | |
|---|-------------------------------|
| 1½ teaspoons active dry yeast | 2 tablespoons honey |
| ¼ cup warm water | 1 teaspoons salt |
| ¾ cup + 2 tablespoons milk | 1½ cups whole wheat flour |
| 2 tablespoons butter or margarine, melted | 1 to 2 cups all-purpose flour |

In a large mixing bowl, combine yeast and water. Stir until dissolved. Add milk, butter, honey, and salt. Stir until mixed. Add whole wheat flour and 1 cup of all-purpose flour and mix until blended. Add enough of the remaining flour and continue kneading until dough forms a smooth ball that is slightly sticky to the touch. Place dough in large, greased bowl and cover with a towel. Let rise until double in size, about an hour. Punch dough down and shape into loaf. Place loaf into 9x5-inch greased loaf pan and let rise until double in size, about 1 hour. Bake in 400°F oven about 30 minutes.

Substitution: Follow the recipe, using the given amounts of whole wheat bread and all-purpose flour. Substituting all whole-wheat flour can result in a coarse and dense texture.

Success Tip!

Always store honey at room temperature, not in the refrigerator. Refrigeration promotes crystallization. Some crystallization will occur even at room temperature and this is normal. To remove crystals, place the jar of honey in warm water until crystals melt.

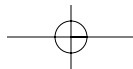
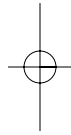
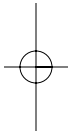

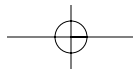
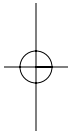

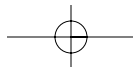
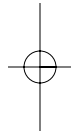
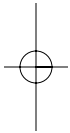

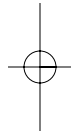

HAMILTON BEACH  PROCTOR-SILEX, INC.
263 Yadkin Road, Southern Pines, North Carolina 28387

840130300

hamiltonbeach.com

8/04

