

# **Hamilton Beach™**

---

## **Water Dispenser**

## **Use & Care Manual**

**Model 2202  
Modelo 2202**

# **INTRODUCTION TO YOUR NEW HAMILTON BEACH™** **WATER DISPENSER (model 2202)**

Congratulations, you have acquired a high quality Hamilton Beach™ Water Dispenser for bottled water. This unit is packed with many extra features that you will find convenient to use. Multi-temperature capability allows you to enjoy a cool drink, hot beverage or simply cook your meals. It will provide you with many years of trouble free use if you follow the safety precautions and operating instructions provided in this easy-to-use manual. Please take the time to read it, and save these instructions for future use. Please also remember to record the model and series code. They are on a label in back of the unit.

---

Model number

---

Series code

---

Date of purchase



**READ ALL INSTRUCTIONS BEFORE USING!**

## **IMPORTANT SAFEGUARDS**

---

When using electrical appliances, basic safety precautions should be followed, including the following:

- **WARNING: BURN HAZARD.** The dispenser heats water to a temperature of approximately 190°F (88°C). Water temperatures above 125°F (52°C) can cause severe burns or death from scalding. Children, the disabled and the elderly are at highest risk of being scalded. Children should be supervised by an adult when using this product.
- **WARNING: CRUSH AND FALL HAZARD.** Do not allow children to climb, stand or hang on the outside of the dispenser, or on the shelves inside the storage cabinet. They could tip the dispenser over or fall and seriously injure themselves. Children should be supervised by an adult when using this product.
- **WARNING: FIRE HAZARD.** Do not store or use gasoline or other flammable vapors and liquids in the vicinity of this or any other appliance. Do not operate dispenser with a damaged cord. Do not use with an underrated extension cord.
- **WARNING: SHOCK HAZARD.** Unplug the water dispenser before cleaning or wiping up spilled water on unit. Do not attempt to service the dispenser. Do not operate dispenser with a damaged cord.
- **WARNING: TOXIC SUBSTANCE HAZARD.** Do not use with water that is microbiologically unsafe or of unknown quality. Do not dispense anything other than water of known quality.
- **CAUTION: SPOILED FOOD HAZARD.** The storage compartment in this unit is not a refrigerator. Do not store perishable food in compartment.

**DANGER: CHILD ENTRAPMENT HAZARD.  
PROPERLY DISPOSE OF THE WATER DISPENSER AS  
DIRECTED BELOW.**

---

Child entrapment and suffocation are not problems of the past. Junked or abandoned dispensers with storage areas are still dangerous... even if they will sit for “just a few days.” If you are getting rid of your old water dispenser, please follow these instructions to help prevent accidents.

**BEFORE YOU THROW AWAY YOUR  
OLD DISPENSER:**

- Take off the doors and discard separately.
- Leave the shelves in place so that children may not easily climb inside.
- If the dispenser door has a lock, make it unusable.

**REFRIGERANT DISPOSAL:**

Your old water dispenser may have used a regulated refrigerant in its cooling system. These refrigerants are believed to harm stratospheric ozone. If you are throwing away your old dispenser, make sure the refrigerant is removed and recovered for proper disposal by an EPA-certified technician. If you intentionally release this refrigerant, you can be subject to fines and imprisonment under provisions of environmental legislation.



**SAVE THESE INSTRUCTIONS!**

---



## **PROPER INSTALLATION AND LOCATION**

---

- 1) Dispenser is for indoor use only. Do not use outdoors.
- 2) To prevent algae growth, find a location for your dispenser that is protected from direct sunlight and other sources of heat (e.g., radiators, baseboard heaters, cooking appliances, etc). Do not use when relative humidity is greater than 90%.
- 3) Do not install the dispenser where the surrounding air temperature will be above 100°F (38°C) or below 50°F (10°C).
- 4) Place the dispenser on a level surface that can support its weight with a full water bottle on it.
- 5) To ensure that your water dispenser works at the maximum efficiency, leave at least 2 inches of clearance between all sides of the dispenser and any walls.
- 6) To prevent damage to dispenser, do not plug dispenser into the power outlet until reading the instructions first!



## **GROUNDING INSTRUCTIONS**

**WARNING – Improper use of the grounding plug can result in a risk of electric shock.**

---

- This appliance must be grounded. In the event of an electrical short circuit, grounding reduces the risk of electric shock.
- This appliance is equipped with a power cord having a grounding wire with a grounding plug. The plug must be plugged into an outlet that is properly installed and grounded.
- Consult a qualified electrician if the grounding instructions are not completely understood, or if doubt exists as to whether the appliance is properly grounded.
- If the outlet is a standard 2-prong wall outlet, it is your personal responsibility and obligation to have it replaced with a properly grounded 3-prong wall outlet.
- Do not under any circumstances cut or remove the third (ground) prong from the power cord.
- Do not use an adapter plug with this appliance.
- Do not use an extension cord with this appliance. If the power cord is too short, have a qualified electrician install an outlet near the appliance
- For best operation, plug the appliance into its own electrical outlet on a dedicated circuit to prevent flickering of lights, blowing of fuse, or tripping of circuit breaker.

## **GETTING FAMILIAR WITH YOUR HAMILTON BEACH WATER DISPENSER**



### **Features:**

- Designed for in home or office use.
- Front panel has three indicator lights, to see if the power, heating and cooling are on.
- Two power switches are located on the back of the dispenser. One is for cooling and one for heating.
- Designed with distinctive thermal isolation technology, this dispenser can minimize thermal exchange between hot and cold water.
- Both hot water tank and cooling tank are 304 stainless steel.
- Convenient, built-in, 0.50 cubic foot storage compartment for non-perishable items.
- Chilling compressor is quiet and durable.
- There are two high-flow faucets on the front of the unit. The faucet with the red child-safety button is for hot water and blue is for cold water.
- Hot water faucet has a child resistant hot water guard. To operate it, push the tab clockwise to disengage the locking device, then push the push button inward.
- Removable, easy-to-clean drip tray.
- The power cord has a grounded plug. Please make sure that your outlet is properly grounded.
- Rated power is 420W for heating and 90W for cooling
- Fits 3 or 5 gallon bottles

## Parts Listing:

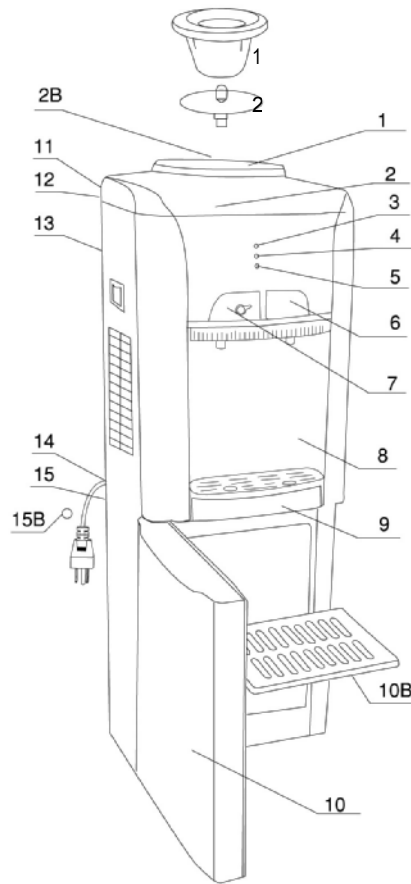

Part No.	Part Name	Part No. Shown on Diagram	Part No.	Part Name	Part No. Shown on Diagram
HB-BS-1003	Bottle Supporter	1	HB-DT-1012	Drip Tray	9
HB-SE-1004	Separator	2	HB-SD-1013	Storage Door	10
HB-CT-1005	Cold Water Tank	2B	HB-RS-1014	Removable Shelf	10B
HB-GIL-1006	Green Indicator Light	3	HB-HS-1015	Heating Switch	11
HB-RIL-1007	Red Indicator Light	4	HB-CS-1016	Cooling Switch	12
HB-BIL-1008	Blue Indicator Light	5	HB-TH-1017	Thermostat (Do not touch)	13 (under panel)
HB-CWF-1009	Cold Water Faucet	6	HB-PC-1018	Power Cord	14
HB-HWF-1010	Hot Water Faucet	7	HB-DOC-1019	Drain Outlet Cap	15
HB-CAS-1011	Casing	8	HB-SS-1020	Silicon Stopper	15B

## **PREPARING, LOADING & OPERATING YOUR DISPENSER**

---

- 1) Make sure that the dispenser is not plugged into the electrical outlet and that both the hot and cold power switches (on the back of the dispenser) are set to the **OFF** position.
- 2) Sanitize the dispenser water tanks prior to installing a full bottle of water for the first time (see “Proper Care and Cleaning of Dispenser”).
- 3) The water bottle will have a cap. The cap may have a stopper that is intended to be pushed into the bottle. (Sometimes these stoppers are covered by a removable paper/foil seal.) If your bottle has a cap with a stopper, simply hold the water bottle vertically straight upside down and place the water bottle into the support collar on top of the water dispenser. The post in the collar will push the stopper into the bottle. If the water bottle cap does not have a stopper that is intended to be pushed into the bottle, first remove the support collar of the water dispenser by turning it counterclockwise and pulling it straight up and off. Then remove the cap from the water bottle. Quickly lift the water bottle, turn it upside down, and place the water bottle onto the top of the water dispenser. Wipe up any water that spills on to the water dispenser or floor.

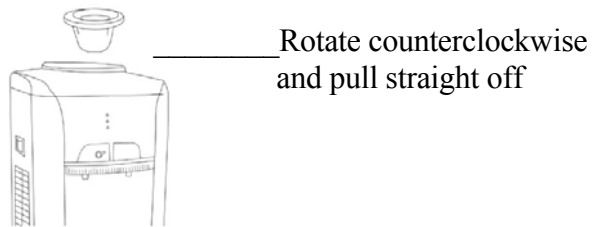

- a. Press the hot and cold dispenser buttons until water runs from all faucets.  
**NOTICE:** To avoid damage to the dispenser, do not plug in the power cord or turn on the heating switch (red) until water runs freely from the hot water faucet when the hot water faucet is activated.
  - b. Plug in the dispenser into a grounded power outlet (see Grounding Instructions).
  - c. Set the **HOT** and **COLD** power switch (located on the rear of the dispenser) to the **ON** position. Indicators light up accordingly once the dispenser is functioning.  
**NOTICE:** To prevent damage to dispenser, give the dispenser four hours to warm up to room temperature before plugging it in if the dispenser is brought in from outside in the winter time.
- 4) Allow 30 minutes for water to reach hot and cold temperatures.

- 5) The hot water temperature is preset to 190 degrees Fahrenheit (88 degrees Celsius). The HOT dispenser button is equipped with a **child safeguard** that reduces the risk of hot water being dispensed accidentally or by small children.

**WARNING: BURN HAZARD.** The dispenser heats water to a temperature of approximately 190 ° F (88 ° C). Water temperatures above 125 ° F (52 °C) can cause severe burns or death from scalding. Children, the disabled and the elderly are at highest risk of being scalded. Children should be supervised by an adult when using this product.

- 6) Before the dispenser leaves the factory, the cold water thermostat is properly set. Do not adjust the thermostat.
- 7) When bottle is empty, vertically pull it out by two hands, then replace it with another bottle.
- 8) The spilled water in the drip tray must be removed regularly and cleaned properly. To remove it, slide tray out.

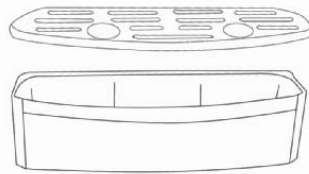

\_\_\_\_\_ Drip Tray Grille

\_\_\_\_\_ Drip Tray

- 9) In case hot or cold water is not needed for an extended period of time, turn off the switch accordingly to save power.  
**NOTICE:** To prevent damage to dispenser, do not turn cold water switch back on within 3 minutes of having turned it off.

## **PROPER CARE AND CLEANING OF DISPENSER**

**WARNING: SHOCK HAZARD.** Unplug the water dispenser before cleaning.

### **Cleaning the Outside and Storage Compartment:**

**IMPORTANT:** Set both power switches (on the back of the dispenser) to the **OFF** position and unplug the water dispenser before cleaning.

The inside and outside of the cabinet can be washed with mild soap and water. Rinse thoroughly with clear water. Never use commercial cleaners or abrasive scouring powders.

Sweep away or vacuum any dust from the condenser coils on the back of the unit. For best results, use a brush specially designed for this purpose. It is available at most appliance stores.

### **Cleaning the Inside of the Storage Compartment:**

For prevention of odor, place an open box of baking soda in the storage compartment.



**IMPORTANT:** Set both power switches (on the back of the dispenser) to the OFF position and unplug the water dispenser before cleaning.

Use a solution of warm water and baking soda (approximately one tablespoon of baking soda to one quart of water). This will clean and neutralize odors. Then rinse and wipe dry.

Other parts of the storage compartment including door gaskets and plastic parts can be cleaned in the same manner.

**NOTICE:** To prevent damage to the water dispenser, the plastic storage parts are not to be washed in the dishwasher.

### **Draining Instruction:**

The dispenser should be drained before cleaning the tanks and before leaving for long vacations or absences.

- 1) Set both power switches (on the back of the dispenser) to the **OFF** position and unplug the dispenser.
- 2) Dispense water from both buttons into container(s) until no more water can be dispensed (about 1 quart of water still remains in the dispenser). Put a container that will withstand hot water under the hot water faucet.
- 3) Remove the water bottle from the dispenser.
- 4) Place a large bucket beneath the drain outlet on the rear of the dispenser.
- 5) Using a Phillips screwdriver, loosen the screws on the bracket covering the drain outlet cap. Rotate the bracket out of the way to allow access to the cap.

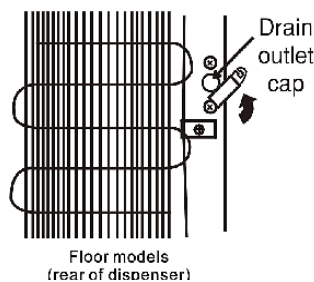

- 6) Remove the cap and silicon stopper from the drain outlet and allow water to drain.

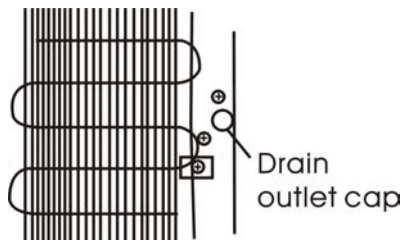

**WARNING: BURN HAZARD.** The dispenser heats water to a temperature of approximately 190 ° F(88 ° C). Water temperatures above 125 ° F (52 °C) can cause severe burns or death from scalding. Children, the disabled and the elderly are at highest risk of being scalded. Children should be supervised by an adult when using this product.

After draining, **replace the silicon stopper and cap.**

- 7) Rotate the bracket back into place and tighten screws.
- 8) Make sure to install a full bottle and dispense water from both water faucets before plugging in and turning on the dispenser (see Preparing, Loading and Operating Your Dispenser).

### **Cleaning the Drip Tray and Grill:**

The drip tray is not self-draining. To reduce water spotting or deposits, the tray and its grill should be emptied, cleaned and wiped dry regularly. Clean with mild soap or on the top rack in the dishwasher.

### **Cleaning the Separator:**

- 1) **IMPORTANT:** Set both power switches (on the back of the dispenser) to the **OFF** position and unplug the water dispenser before cleaning.
- 2) Remove the water bottle and drain the dispenser (see Draining Instruction).
- 3) Remove the support collar by turning counterclockwise and pulling straight off.

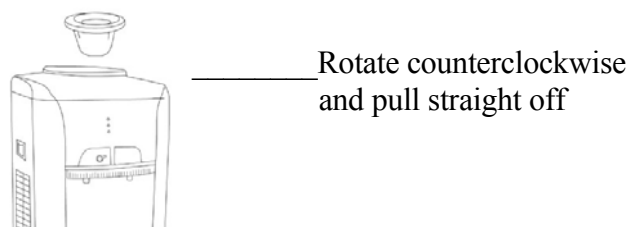

- 4) Remove the plastic separator by pulling straight out (you may need to twist slightly to loosen).

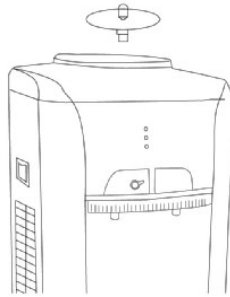

- 5) Clean the separator with dish soap and water or in the top rack of the dishwasher.
- 6) Dry the separator thoroughly on both sides.
- 7) Using a clean cloth or paper towel, thoroughly dry the cold water reservoir.
- 8) Place the separator back in the dispenser. Make sure the long, tapered end of the separator is positioned firmly on the metal plug on the bottom of the reservoir.
- 9) Replace the support collar and turn clockwise until it is firmly in place.
- 10) Install a full water bottle on the dispenser (see Preparing and Loading Your Dispenser for Use).

### **Sanitizing and Cleaning the Water Tanks:**

**Important:** Periodically the water dispenser tanks must be sanitized to prevent unpleasant tastes in the water and cleaned to remove mineral deposits that can impair flow.

### **To Sanitize:**

**Important:** Before cleaning, set both power switches (on the back of the dispenser) to the **OFF** position and **unplug the water dispenser**. **Note:** For first time installation, skip next three steps.

- 1) Empty the water bottle, then remove it from the dispenser.
- 2) Drain the water tanks (see Draining Instruction)

- 3) Reinstall the silicon stopper and drain cap (see Draining Instruction)
- 4) **DO NOT ADD BLEACH FIRST OR DIRECTLY TO THE DISPENSER.**  
Concentrated bleach may damage plastic.
- 5) Add ½ teaspoon (2.5 ml) of ordinary 6.0% maximum household bleach to a 2 quart (2 liter) pitcher filled with tap water.
- 6) Pour the solution in the opening at the top of the dispenser.
- 7) Repeat last two steps until the dispenser is full.
- 8) Press the hot and cold dispenser buttons until the water just begins to flow from the faucets.
- 9) Allow to sit for 15-20 minutes.
- 10) **Rinse out the bleach solution.**
- 11) Drain the water tanks into a large bucket (see Draining Instruction).
- 12) Make sure that the silicon stopper is **NOT** installed.
- 13) **IMPORTANT:** Remove the separator and wipe out the cold water reservoir (see Cleaning the Separator).
- 14) Clean, then reinstall the separator and collar (see Cleaning the Separator).
- 15) Pour approximately 1 gallon (4 quarts or 4 liters) of fresh tap water into the top and allow to drain into the bucket.
- 16) Flush with an additional 1 gallon (4 quarts or 4 liters) of fresh tap water and allow to drain into the bucket.
- 17) **Reinstall the silicon stopper and drain cap** (see Draining Instruction).
- 18) Install a fresh water bottle (see Preparing and Loading Your Dispenser for Use).
- 19) Dispense 1 quart (1 liter) of water from each faucet and taste to make sure the bleach solution is completely removed.
- 20) If you continue to taste the chlorine from the bleach solution, **repeat steps 11 – 20** until the taste is gone.
- 21) Plug in the dispenser. Then turn on the hot and cold power switches (on the back of the dispenser).

### **To Remove Mineral Deposits:**

Mix 2 quarts (2 liters) of water with two quarts of vinegar **OR** mix 1 gallon of water (4 liters) with 16 ounces (454 g) of citric acid crystals. Bleach does not remove mineral deposits. Do this in place of step 6 above when removing mineral deposits.

### **Preparing for Vacation:**

For long vacations or absences, set both power switches (on back of the dispenser) to the **OFF** position.

Unplug the water dispenser.

Remove the water bottle.

Drain the water tanks (see Draining Instructions)

Dry the separator thoroughly on both the top and bottom (see Cleaning the Separator).

After returning from vacation, make sure to sanitize the water tanks before using the dispenser (see Sanitizing and Cleaning the Water Tank).

## **TROUBLE SHOOTING**

---

<b><u>PROBLEM</u></b>	<b><u>POSSIBLE CAUSES</u></b>	<b><u>SOLUTION</u></b>
No hot or cold water	1. over consumption of hot or cold water in short period of time	1. wait 30 minutes before using again
	2. no power supply	2. connect plug to socket, turn on heating or cooling switch.
Water is not cool	Dispenser is unplugged	Push plug completely into outlet
	Cooling switch not on	Check to be sure cooling switch is turned to <b>ON</b>
	The fuse is blown/circuit breaker is tripped	Replace house fuse or reset circuit breaker.  If too many items are plugged into a single circuit, move some items to a different circuit

	Temperature limiter tripped	Set the hot and cold power switches to <b>OFF</b> position. Wait five minutes, then set switches to <b>ON</b> position. Wait 30 minutes for water to heat or cool.
Water is not hot	Dispenser is unplugged	Push plug completely into outlet
	Heating switch not on	Check to be sure heating switch is turned to <b>ON</b>
	The fuse is blown/circuit breaker is tripped	Replace house fuse or reset circuit breaker.  If too many items are plugged into a single circuit, move some items to a different circuit
	Temperature limiter tripped	Set the hot and cold power switches to <b>OFF</b> position. Wait five minutes, then set switches to <b>ON</b> position. Wait 30 minutes for water to heat or cool.

<b><u>PROBLEM</u></b>	<b><u>POSSIBLE CAUSES</u></b>	<b><u>SOLUTION</u></b>
No water running out from faucets	1. empty bottle 2. inlet of bottle supporter blocked by bottle seal	1. replace with new bottle 2. clean out wasted paper and bottle seal, install bottle again
Water dispenser does not work	1. empty water bottle 2. mineral deposits clogging tank	1. replace with new bottle 2. see Care and Cleaning.
Water dispenser leaks from the outside	crack or pin hole in bottle	replace with new bottle
Compressor runs too frequently	1. room temperature is hotter than normal	This may be necessary to maintain a constant temperature during hot and humid days
	2. dispenser does not have proper clearance	Check to be sure unit is properly located to ensure adequate airflow
Noisy operation	improper installation	place the machine on level surface

	Bottle making a gurgling noise	this is normal
	Hot water boiling sound	this is normal
	Dispenser or water bottle shakes when the cooling system cycles off	this is normal
Particles floating in Water	Water has high mineral content	find a water source with lower hardness
Water in bottle is hot	Water is boiling in the hot tank and bubbling up into the bottle	press the hot dispenser button until water flows to remove air from the hot tank
Foul odor in air around dispenser	Hot water tank is empty or not completely full	press the hot dispenser button until water flows to remove air from the hot tank
Water has poor taste or odor	Separator needs cleaning	See Cleaning the Separator
	Unit needs to be sanitized	See Cleaning and Sanitizing the Water Tanks.

## **Consumer Support**

---

Questions? How to contact us: Telephone 800-488-5080 (Monday – Friday 8:00AM-5:00 PM ET)

E-mail: [sales@hbwaterdispensers.com](mailto:sales@hbwaterdispensers.com)

[support@hbwaterdispensers.com](mailto:support@hbwaterdispensers.com)

---



## **LIMITED 1-YEAR WARRANTY**

What does this warranty cover?

- Any defect in materials or workmanship in the manufactured product

What does this warranty not cover?

- Water Bottles
- Service trips to your home to teach you how to use the product.
- Improper installation.
- Failure of the product if it is abused, misused, altered or used for other than the intended purpose.
- Products that are used outside a residential or office environment.
- Replacement of house fuses or resetting of circuit breakers.
- Use of this product where water is microbiologically unsafe or of unknown quality.
- Damage to the product if used to dispense anything other than water.
- Damage to the product caused by accident, fire, floods or acts of God.
- Any service to the product
- **Incidental or consequential damage caused by possible defects with this appliance, its installation or repair.**

For how long after the original purchase?

- One (1) year.

How do I make a warranty claim?

- **Return to the retailer from which it was purchased, along with a copy of the store receipt within the given period of time allowed for returns by the retailer (i.e. 90 days). After this period of time, contact TTI Appliances at 1 800 579 7990. A refund will be provided once the defective unit and a copy of the receipt has been shipped to and received by TTI Appliances. This warranty excludes any cost of shipping to or from TTI Appliances.**

How does state law relate to this warranty?

- This warranty is extended to the original purchaser and any succeeding owner for products purchased for home or office use within the USA. **Some states do not allow the exclusion or limitation of incidental or consequential damages. This warranty gives you specific legal rights, and you may also have other rights which vary from state to state. To know what your legal rights are, consult your local or state consumer affairs office or your state's Attorney General.**

**Exclusion of implied warranties: Except where prohibited or restricted by law, there are no warranties, whether express, oral or statutory which extend beyond the description on the face hereof, including specifically the implied warranties of merchantability or fitness for a particular purpose.**

**Warrantor: TTI Appliances, Los Angeles, CA 90025**

---

## IMPORTANT NOTICES

1. TO PREVENT DAMAGE TO WATER DISPENSER, LET UNIT STAND UPRIGHT FOR A MINIMUM OF FOUR HOURS BEFORE PLUGGING IN POWER CORD.

2. TO PREVENT DAMAGE TO WATER DISPENSER, DO NOT PLUG IN OR TURN ON YOUR WATER DISPENSER UNLESS THERE IS WATER IN THE SYSTEM.

3. ODORS MAY RESULT IF THE WATER HEATER COMES ON WHEN THERE IS NO WATER IN THE TANK.

4. PRIOR TO FIRST USE, PLEASE REMOVE CARBON ABSORBENT BAG ATTACHED TO THE OUTSIDE OF CONDENSOR ON THE BACK OF YOUR NEW DISPENSER, AND DISPOSE OF PROPERLY.

## QUICK START INSTRUCTIONS

1. ENSURE THE DISPENSER IS UNPLUGGED AND SWITCHED OFF.

2. CLEAN AND SANITIZE THIS DISPENSER BEFORE USE. NOTICE: TO PREVENT DAMAGE TO DISPENSER, FOLLOW THE DIRECTIONS IN YOUR OWNER'S MANUAL.

3. LOAD A NEW BOTTLE. NOTICE: TO PREVENT DAMAGE TO DISPENSER, FOLLOW THE DIRECTIONS IN YOUR OWNER'S MANUAL.

4. DISPENSE A SMALL AMOUNT OF WATER FROM EACH FAUCET.

5. PLUG IN AND TURN ON YOUR DISPENSER

QUESTIONS? Call 1-800-488-5080

## NOTA IMPORTANTE

PARA PREVENIR DAÑOS DEJE LA UNIDAD DE PIE POR UN MÍNIMO DE CUATRO HORAS ANTES DE CONECTAR EL CABLE ELÉCTRICO.

PARA PREVENIR DAÑOS NO ENCHUFE O ENCIENDA SU DISPENSADOR DE AGUA A NO SER QUE HAYA AGUA EN EL SISTEMA

PODRÍAN RESULTAR MALOS OLORES SI EL CALENTADOR DE AGUA ES ENCENDIDO CUANDO NO HAY AGUA EN EL TANQUE

ANTES DE USARLO POR PRIMERA VEZ, REMUEVA LA BOLSA DE CARBON ABSORBENTE ADHERIDO A LA PARTE POSTERIOR DE ESTE DISPENSADOR, Y PONGALE EN LA BASURA.

## INSTRUCCIONES RÁPIDAS

ASEGÚRESE DE QUE EL DISPENSADOR ESTA DESCONECTADO Y APAGADO

LIMPIE Y DESINFECTE ESTE DISPENSADOR ANTES DE USAR. NOTA: PARA PREVENIR DAÑOS SIGA LAS INSTRUCCIONES EN SU MANUAL DE PROPIETARIO.

COLÓQUESE UNA BOTELLA LLENA. PARA PREVENIR DANOS SIGA LAS INSTRUCCIONES EN U S MANUAL DE PROPIETARIO

DEJE CORRER PEQUEÑA PORCIÓN DE AGUA DE CADA GRIFO.

ENCHUFE Y ENCIENDA SU DISPENSADOR

PREGUNTAS? LLAME AL 1-800-488-5080

## HAMILTON BEACH™ WATER DISPENSER QUICK START GUIDE

### GUIA RAPIDA PARA DISPENSADOR DE AGUA HAMILTON BEACH™ . . .

### WELCOME TO ANOTHER GREAT HAMILTON BEACH™ PRODUCT

### BIENVENIDO A OTRO FABULOSO PRODUCTO DE HAMILTON BEACH™



OFF position

Posicion APAGADO (OFF)

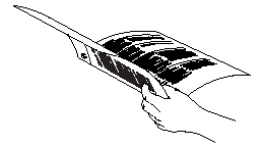

ON position

Posicion ENCENDIDO (ON)