

READ BEFORE USE

使用前阅读

Visit www.hamiltonbeach.cn for our complete line of products and Use and Care Guides – as well as delicious recipes, tips, and to register your product online!

有关我们所有系列产品的，使用与维护指南 – 以及美味食谱、生活小贴士和产品在线注册的更多信息，请访问 www.hamiltonbeach.cn。

Questions?

Please call us – our friendly associates are ready to help.
China: 400-852-2655

如有疑问?

请致电我们，我们的团队随时准备为您提供帮助。
中国大陆免费客服热线：
400-852-2655
官方网站：www.hamiltonbeach.cn

型号：59769-CN

此说明书中图片仅供参考，产品以实物为准。

使用本设备前，我们建议您仔细阅读这些说明。

Hamilton 汉美驰 Beach®



Stainless Steel Hand Blender 不锈钢多功能 手持搅拌器

English 2
简体中文 7

IMPORTANT SAFEGUARDS

When using electrical appliances, basic safety precautions should always be followed to reduce the risk of fire, electric shock, and/or injury to persons, including the following:

1. Read all instructions.
2. This appliance is not intended for use by persons (including children) with reduced physical, sensory, or mental capabilities, or lack of experience and knowledge, unless they are closely supervised and instructed concerning use of the appliance by a person responsible for their safety.
3. Close supervision is necessary when any appliance is used by or near children. Children should be supervised to ensure that they do not play with the appliance.
4. To protect against risk of electrical shock, do not put motor housing, cord, or plug in water or other liquid.
5. Avoid contact with moving parts. Keep hands, hair, clothing, and utensils away from blades and out of container during operation to prevent the possibility of severe injury to persons and/or damage to the appliance. A scraper may be used but must be used only when the unit is not running.
6. The use of attachments not recommended or sold by the appliance manufacturer for use with this model may cause fire, electric shock, or injury.
7. When mixing liquids, especially hot liquids, use a tall container or make small quantities at a time to reduce spillage.
8. Blades are sharp; handle carefully.
9. Do not use over a stove or other heat source.
10. Do not use outdoors.
11. Do not let cord hang over edge of table or counter.
12. Do not let cord contact hot surfaces, including the stove.
13. Do not place appliance on or near a hot gas or electric burner, or in a heated oven.
14. Unplug from outlet when not in use, before putting on or taking off parts, and before cleaning.
15. Do not operate any appliance with a damaged supply cord, or after the appliance malfunctions, or is dropped or damaged in any manner. All repairs must be conducted by the manufacturer, its service agent, or similar qualified persons in order to avoid a hazard. Call our toll-free customer service number for information on examination, repair, or electrical or mechanical adjustment.
16. Be certain the cover is securely locked in place before operating appliance.
17. **CAUTION:** In order to avoid a hazard due to inadvertent resetting of the thermal cut-out, this appliance must not be supplied through an external switching device, such as a timer, or connected to a circuit that is regularly switched on and off by the utility.

SAVE THESE INSTRUCTIONS!

Other Consumer Safety Information

This product is intended for household use only.

This product is only intended for the preparation, cooking, and serving of foods. This product is not intended for use with any nonfood materials or products.

The length of the cord used on this appliance was selected to reduce the hazards of becoming tangled in or tripping over a longer cord. If a longer cord is necessary, an approved extension cord may be used. The electrical rating of the extension cord must be

equal to or greater than the rating of the appliance. Care must be taken to arrange the extension cord so that it will not drape over the countertop or tabletop where it can be pulled on by children or accidentally tripped over.





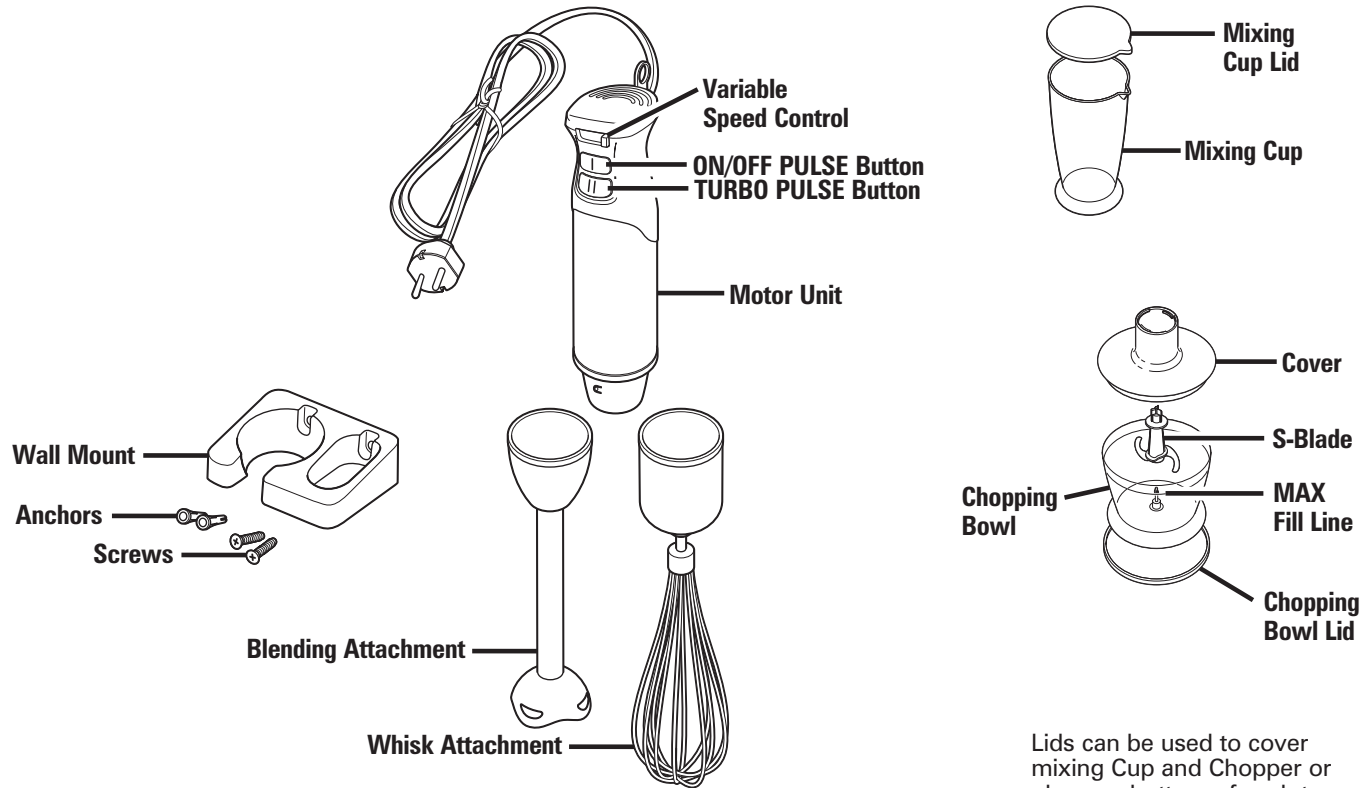

















To avoid an electrical circuit overload, do not use another high-wattage appliance on the same circuit with this appliance.

Parts and Features



Lids can be used to cover mixing Cup and Chopper or place on bottom of each to protect a surface.

Blending Guide

FOOD	SPEED	ATTACHMENT
	LO	
	TURBO	
	LO	
	LO	
	HI	
	LO	
	LO	  
	TURBO	
	TURBO	  

ON/OFF PULSE Button
TURBO PULSE Button



Variable Speed Control
(LO, MED, HIGH Switch)

Helpful hints

- The hand blender is not designed for use over a heat source.
- This appliance is not intended to chop ice. Add ice to beverage after blending.
- To use the hand blender in a saucepan, be sure to remove the pan from the stove.
- To puree foods, liquid is needed. Add cooking liquid, broth, juice, milk, or cream until desired consistency is reached.
- For thorough blending, move hand blender up and down in mixture until smooth.
- To achieve best blending results and to reduce splattering (especially hot foods or liquids), use deep, tall containers.
- The plastic lid of the measuring jar may be flipped upside down and placed underneath the base of the cup or chopping bowl in order to provide a more stable surface while blending.
- Suggest the Max operation duration as 30 seconds.
- The 2:3 scale of carrot and water for blender is preferred, 150g meat (beef .etc) for chopper is preferred.

How to Install Wall Mount

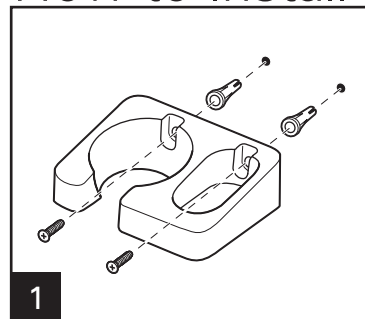

Attach wall mount to wall using the included anchors and screws.

How to Use the Hand Blender/Whisk Attachment

Set the variable speed level first and then press the ON/OFF PULSE button. Variable speed is for the ON/OFF PULSE button only. The TURBO PULSE button is not affected by the variable speed button.

⚠ WARNING Cut Hazard.

Always inspect attachments before each use. Do not use cracked, bent, or damaged attachments.

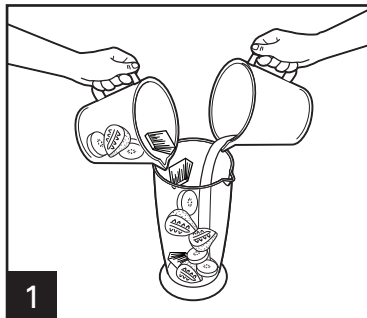

Do not use frozen ingredients.

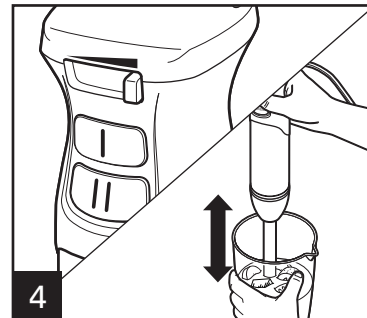
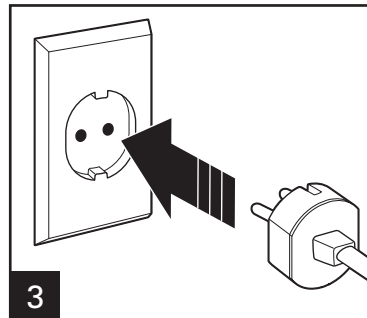
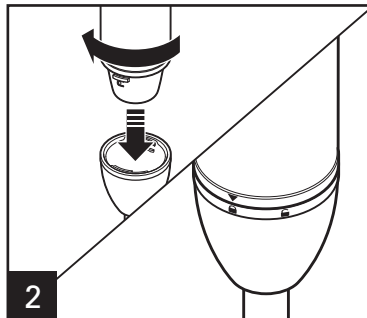

NOTE: Do not immerse the motor unit past the top metal portion of each attachment.

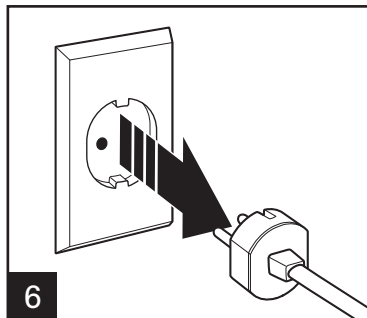

NOTE: Do not use nonfood items in this hand blender. This product is not meant for soap making.

How to Use the Chopper

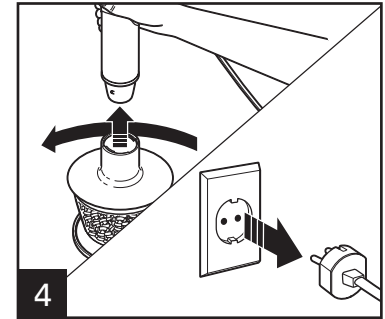
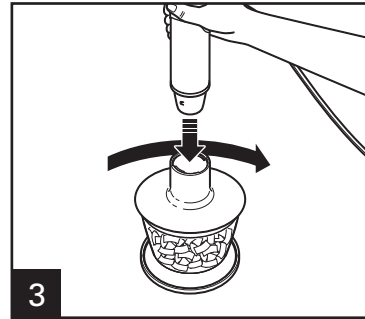
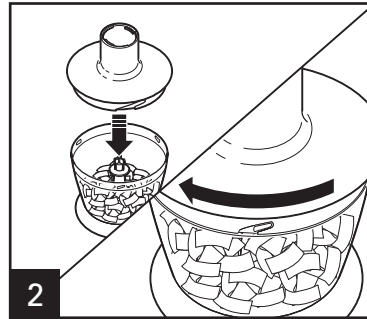
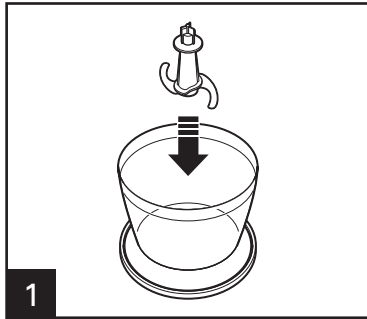

How to Clean the Hand Blender

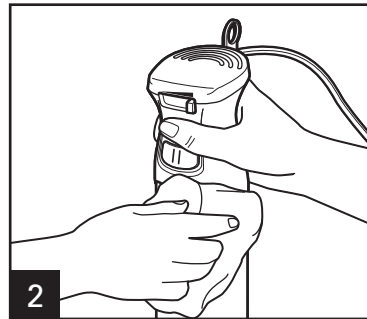
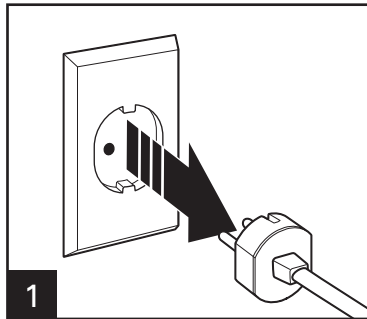

⚠ WARNING
Electric Shock Hazard.
Never hold motor housing portion of hand blender under running water. Simply wipe clean with a damp cloth.

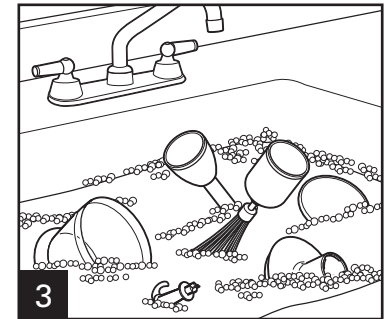

重要安全说明

当使用电器时，应始终遵守基本的安全防范措施，以减少火灾、触电和/或人身伤害的风险，包括以下内容：

1. 阅读所有相关说明。
2. 本电器不适合以下人群（包括儿童）使用：行动不便者、精神或智商缺陷者、或缺乏经验和常识者，除非他们在责任人的密切监督和指导下使用，以确保安全。
3. 当电器由儿童使用、或在其附近使用时，应予以密切监护。确保本电器勿用于儿童玩耍。
4. 为防止触电，请勿将电机底座、电源线或插头放入水或其他液体中。
5. 避免接触正在运动的部件。操作过程中，保持双手、头发、衣物和器具远离刀片和容器，以防造成可能严重的人身伤害和/或电器损坏。可使用刮铲，但仅限于在装置未运行时使用。
6. 将非电器制造商推荐或出售的配套附件用于本机型可能会导致火灾、电击或人身伤害。
7. 搅拌液体尤其是热液体时，请使用高容器或一次制作小份量，以减少溢出。
8. 刀片很锋利；请小心处理。
9. 请勿在电炉或其他热源上使用本机。
10. 请勿户外使用。
11. 请勿将电源线搭置在桌台或柜台边缘。
12. 请勿让电线接触热表面，包括电炉。
13. 请勿将电器置于燃气、电炉、热烤箱上面或附近。
14. 本电器不使用时、安装或拆装部件、以及清洁前，需拔掉电源插头。
15. 在下列情况下，请勿使用电器：电源线破损、电器出现故障、电器曾跌落或已经出现任何形式的损坏。所有维修必须由制造商、维修代理商或同等资质的人员进行，以避免险情。请拨打我们的免费售后服务电话，咨询有关电器检查、修理或调整的相关信息。如果电源软线损坏，为了避免危险，必须由制造商、其维修部或类似部门的专业人员更换。
16. 操作电器前，务确保盖子已安全锁定到位。
17. **小心：** 为了避免由于热熔断器的疏忽重置导致的危险，本电器不能在外接定时器或独立的遥控控制系统的方式下运行。

请妥善保管这些说明！

其他用户安全信息

本产品建议于家庭使用。

本产品仅用于配制、烹饪和加工食物。本产品不可用于加工任何非食物材料。

此电器电源线的长度设计考虑减少长电源线缠绕或绊倒的危险。倘若需要更长的电源线，可使用有认证的电源延长线。电源延长线的额定功率

必须等于或大于此电器的额定功率。电源延长线使用时需特别注意，以防将其搭设在工作台或桌面上，造成儿童扯拉或绊倒他人。





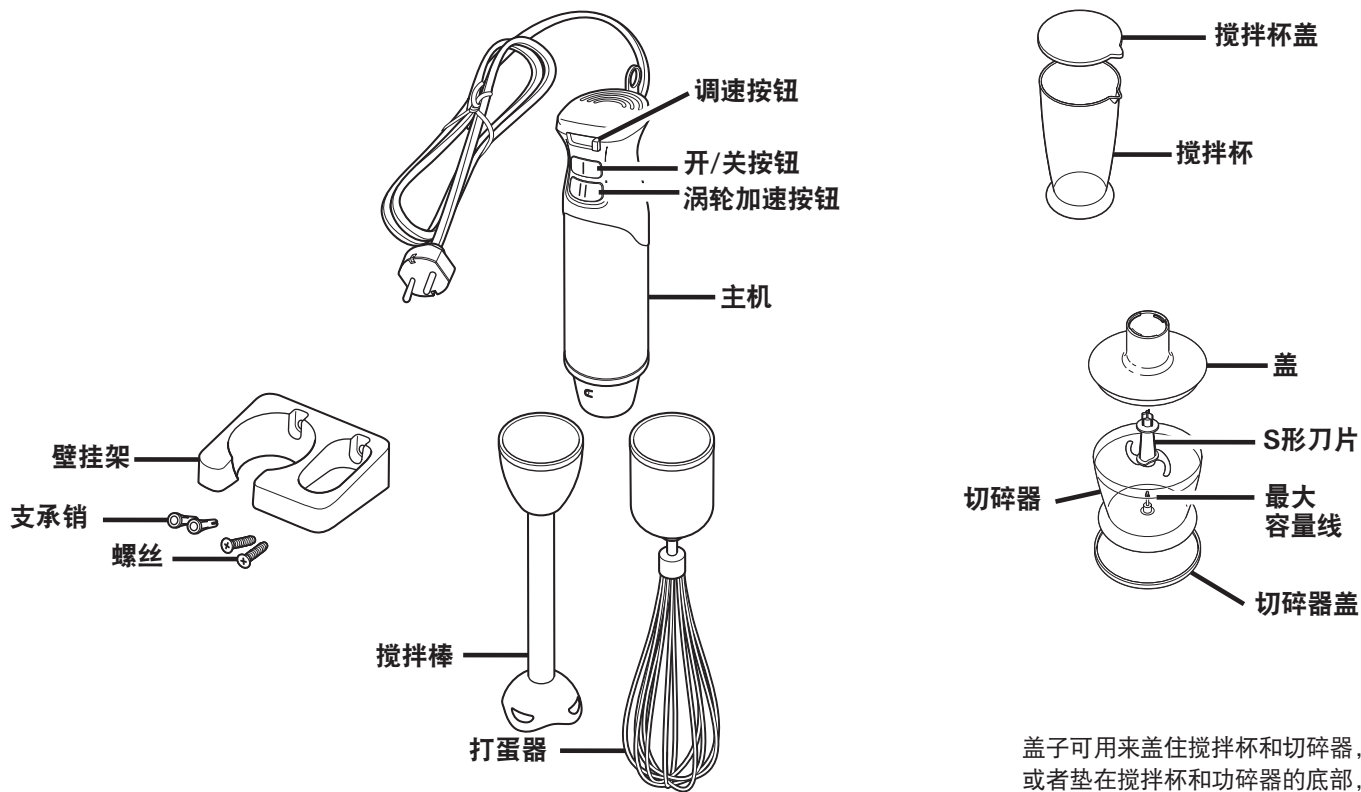

















为防电路过载，请勿在此电器的同一电路上使用其他高功率电器。

部件和功能



盖子可用来盖住搅拌杯和切碎器，
或者垫在搅拌杯和功碎器的底部，
以保护台面。

搅拌指南

食物	速度	附件
	低速	
	涡轮	
	低速	
	低速	
	高速	
	低速	
	低速	  
	涡轮	
	涡轮	  



有用提示

- 该手持搅拌器不能在热源上使用。
- 本电器不用于碎冰。搅拌后向饮料内加入冰块。
- 若要在锅中使用手持搅拌器，请务必将锅从炉子上拿下。
- 若要将食物打成泥，需要液体。加入蒸煮液、肉汤、果汁、牛奶、奶油等一起搅拌，直到达到所需的稠度。
- 为彻底搅拌，请将手持搅拌器在混合物中上下移动，直到搅拌均匀。
- 为达到最佳搅拌效果并减少飞溅（尤其是热食物或液体），请使用深且高的容器。
- 搅拌杯和切碎器的盖子可反转垫在搅拌杯和切碎器的底部，使搅拌时，底部更稳固。
- 建议最长持续操作时间为30秒。
- 建议搅拌棒打2:3的红萝卜与水，切碎器打150克的肉(牛肉等)效果较佳。

如何安装壁挂架

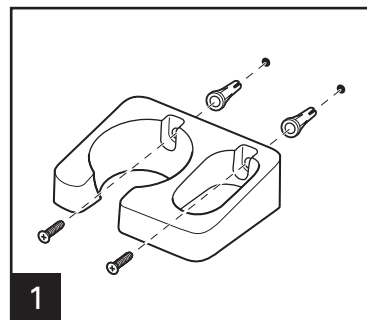

使用随附支承销和螺丝将壁挂架安装到墙壁上。

如何使用手持搅拌机/打蛋器附件

先使用调速按钮调节速度，然后按“开/关”按钮。仅使用“开/关”按钮才可实现调速功能。“涡轮加速”按钮不受调速按钮的影响。

警告 切伤危险。
每次使用前务必检查各附件。请勿使用碎裂、弯曲或损坏的附件。

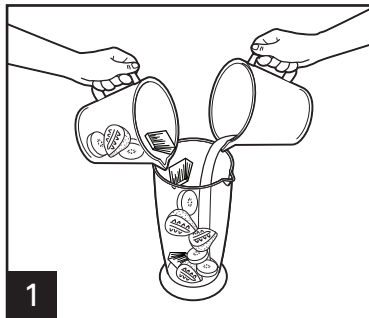

请勿使用冰冻材料。

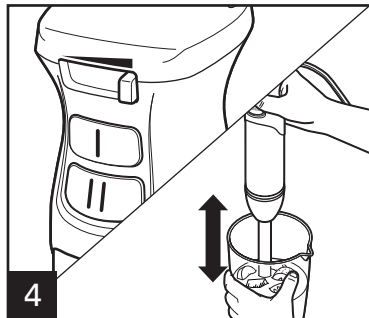
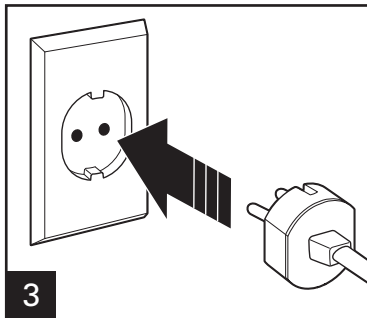
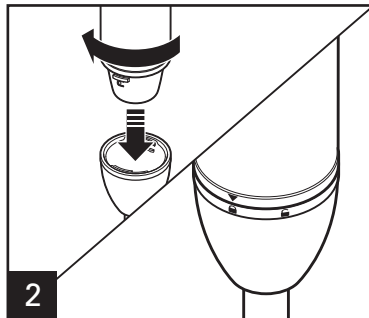

注意：使用每个附件搅拌时，请勿将主机浸入超过金属部分。

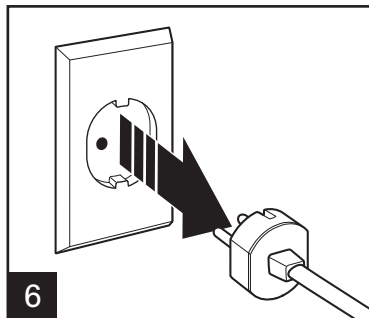

注意：请勿用本机搅拌非食物材料。本产品不可用于制皂。

如何使用切碎器

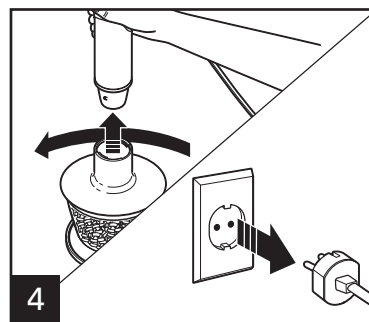
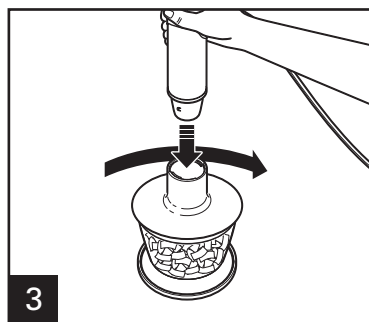
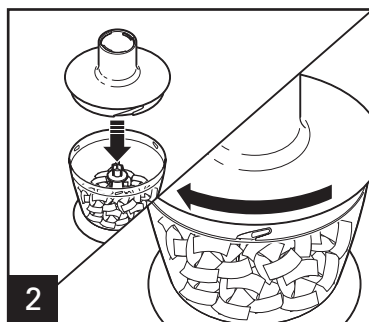
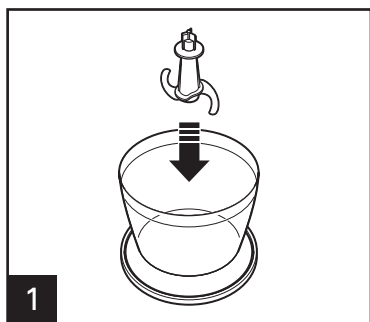

如何清洁手持搅拌器

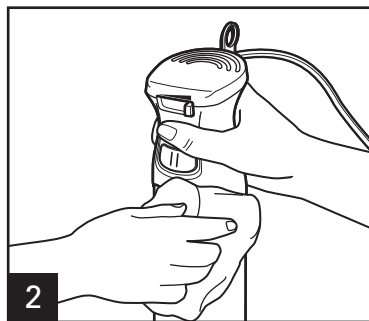
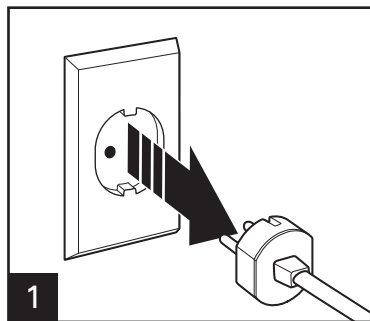

警告
电击危险。
切勿将手持搅拌器的电机部分置于
自来水下。只可用湿布擦干净。

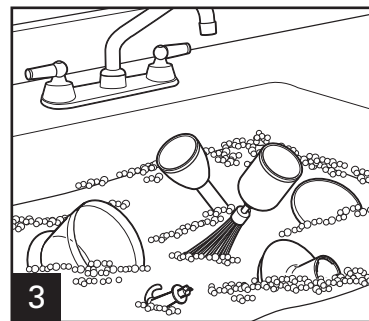

Model/型号:
59769-CN

Type/类别:
HB10

Rating/规格:
220-240V~ 50/60Hz 600W

Dist.: Hamilton Beach Brands, Inc., Glen Allen, VA 23060
© 2014 Hamilton Beach Brands, Inc.

以上内容如有改动，恕不预先通知

840240800