

READ BEFORE USE

Visit www.hamiltonbeach.in for our complete line of products and Use and Care Guides – as well as delicious recipes, tips, and other useful information!

Questions?
Please call us – our friendly associates are ready to help.
1.800.42.555.43

Hamilton Beach®

Stainless Steel Hand Blender



IMPORTANT SAFEGUARDS

When using electrical appliances, basic safety precautions should always be followed to reduce the risk of fire, electric shock, and/or injury to persons, including the following:

1. Read all instructions.
2. This appliance is not intended for use by persons (including children) with reduced physical, sensory, or mental capabilities, or lack of experience and knowledge, unless they are closely supervised and instructed concerning use of the appliance by a person responsible for their safety.
3. Close supervision is necessary when any appliance is used by or near children. Children should be supervised to ensure that they do not play with the appliance.
4. To protect against risk of electrical shock, do not put motor housing, cord, or plug in water or other liquid.
5. Avoid contact with moving parts. Keep hands, hair, clothing, and utensils away from blades and out of container during operation to prevent the possibility of severe injury to persons and/or damage to the appliance. A scraper may be used but must be used only when the unit is not running.
6. The use of attachments not recommended or sold by the appliance manufacturer for use with this model may cause fire, electric shock, or injury.
7. When mixing liquids, especially hot liquids, use a tall container or make small quantities at a time to reduce spillage.
8. Blades are sharp; handle carefully.
9. Do not use over a stove or other heat source.
10. Do not use outdoors.
11. Do not let cord hang over edge of table or counter.
12. Do not let cord contact hot surfaces, including the stove.
13. Do not place appliance on or near a hot gas or electric burner, or in a heated oven.
14. Unplug from outlet when not in use, before putting on or taking off parts, and before cleaning.
15. Do not operate any appliance with a damaged supply cord, or after the appliance malfunctions, or is dropped or damaged in any manner. All repairs must be conducted by the manufacturer, its service agent, or similar qualified persons in order to avoid a hazard. Call our toll-free customer service number for information on examination, repair, or electrical or mechanical adjustment.
16. Be certain the cover is securely locked in place before operating appliance.

SAVE THESE INSTRUCTIONS!

Other Consumer Safety Information

This product is intended for household use only.

This product is only intended for the preparation, cooking, and serving of foods. This product is not intended for use with any nonfood materials or products.

The length of the cord used on this appliance was selected to reduce the hazards of becoming tangled in or tripping over a longer cord. If a longer cord is necessary, an approved extension cord may be used. The electrical rating of the extension cord must be

equal to or greater than the rating of the appliance. Care must be taken to arrange the extension cord so that it will not drape over the countertop or tabletop where it can be pulled on by children or accidentally tripped over.





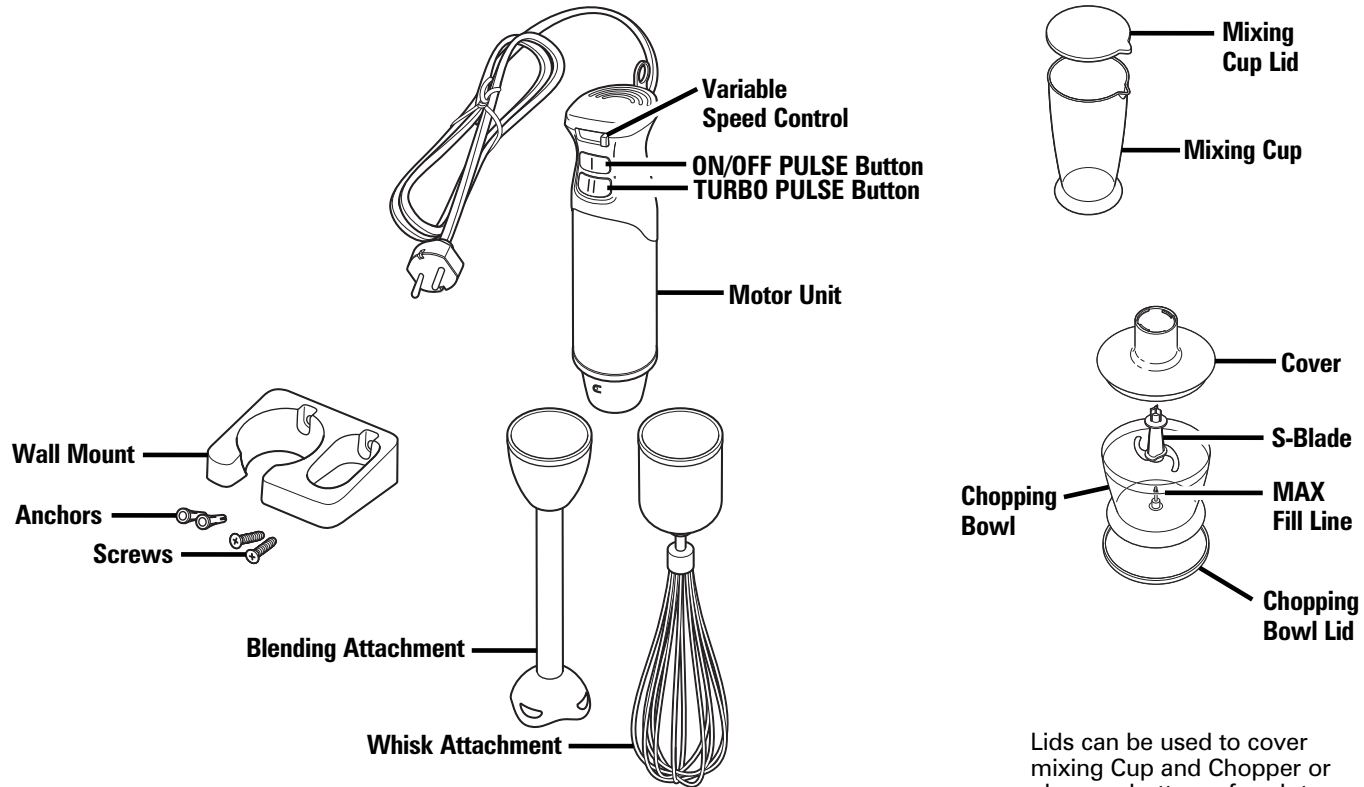













To avoid an electrical circuit overload, do not use another high-wattage appliance on the same circuit with this appliance.

Parts and Features



Lids can be used to cover mixing Cup and Chopper or place on bottom of each to protect a surface.

Blending Guide

FOOD	SPEED	ATTACHMENT
	LO	
	TURBO	
	LO	
	LO	
	HI	
	LO	
	LO	
	TURBO	
	TURBO	

4

ON/OFF PULSE Button
TURBO PULSE Button



Variable Speed Control
(LO, MED, HIGH Switch)

Helpful hints

- The hand blender is not designed for use over a heat source.
- This appliance is not intended to chop ice. Add ice to beverage after blending.
- To use the hand blender in a saucepan, be sure to remove the pan from the stove.
- To puree foods, liquid is needed. Add cooking liquid, broth, juice, milk, or cream until desired consistency is reached.
- For thorough blending, move hand blender up and down in mixture until smooth.
- To achieve best blending results and to reduce splattering (especially hot foods or liquids), use deep, tall containers.
- The plastic lid of the measuring jar may be flipped upside down and placed underneath the base of the cup or chopping bowl in order to provide a more stable surface while blending.
- Maximum operation duration is 30 seconds.

How to Install Wall Mount

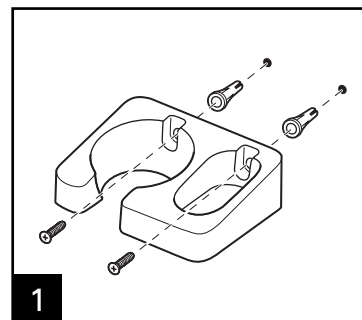

Attach wall mount to wall using the included anchors and screws.

How to Use the Hand Blender/Whisk Attachment

Set the variable speed level first and then press the ON/OFF PULSE button. Variable speed is for the ON/OFF PULSE button only. The TURBO PULSE button is not affected by the variable speed button.

⚠ WARNING Cut Hazard.

Always inspect attachments before each use. Do not use cracked, bent, or damaged attachments.

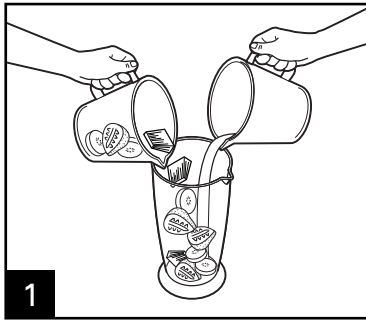

Do not use frozen ingredients.

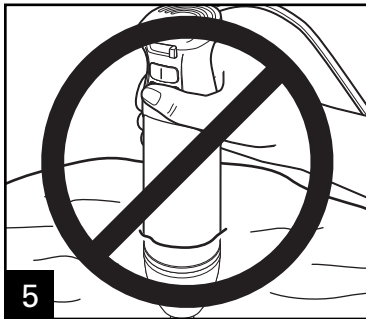
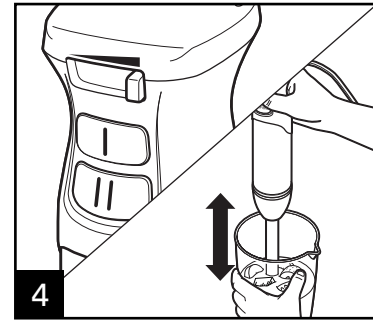
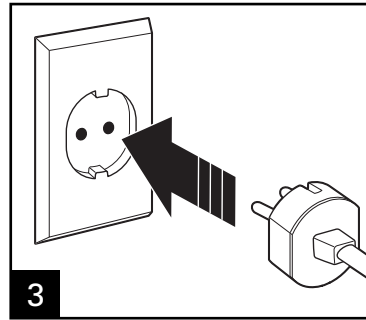
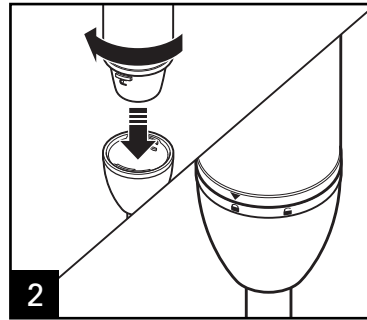

NOTE: Do not immerse the motor unit past the top metal portion of each attachment.

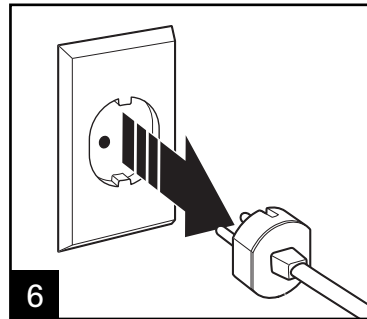

NOTE: Do not use nonfood items in this hand blender. This product is not meant for soap making.

How to Use the Chopper

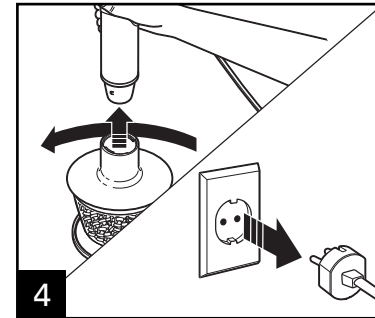
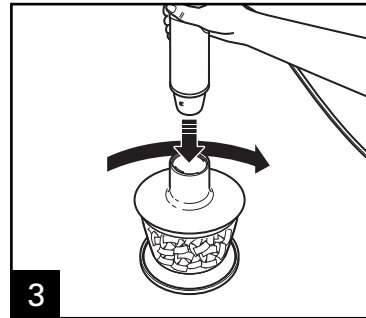
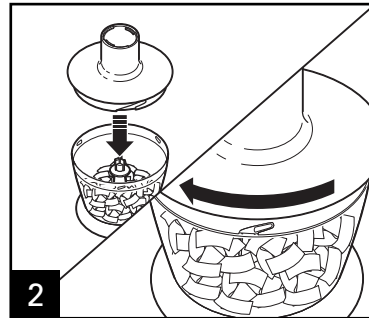
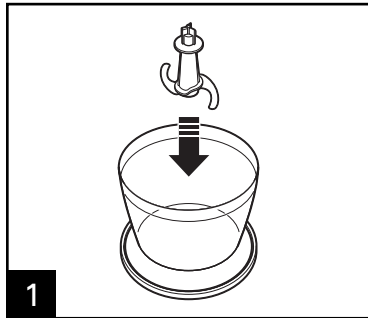

How to Clean the Hand Blender

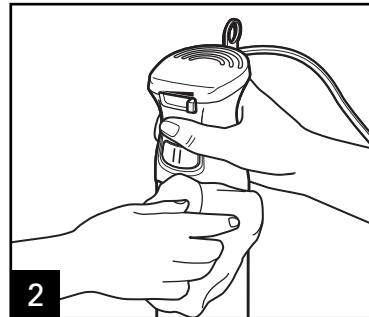
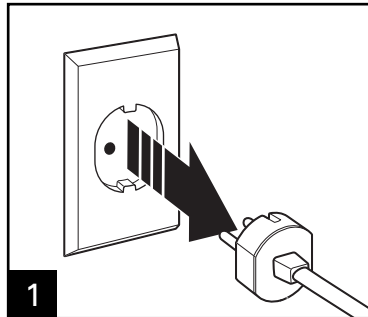

⚠ WARNING
Electric Shock Hazard.
Never hold motor housing portion of hand blender under running water. Simply wipe clean with a damp cloth.

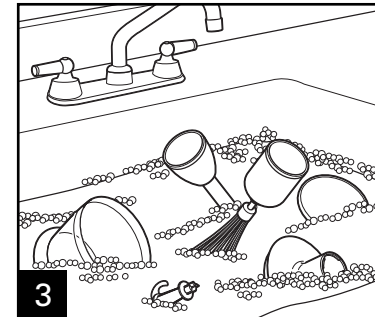

Notes

Limited Warranty

CUSTOMER NAME: _____
ADDRESS: _____
PHONE NUMBER: _____
MODEL NUMBER: _____
DATE OF PURCHASE: _____ BILL NUMBER: _____

NAME OF DEALER: _____
DEALER'S SIGNATURE: _____
CUSTOMER'S SIGNATURE: _____
STAMP:

SERIAL NUMBER:

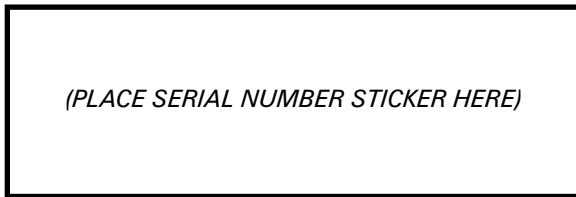

EXPIRY DATE:

SHOULD ANY DEFECT IN MATERIAL OR WORKMANSHIP DEVELOP IN THE PRODUCT,

- CALL 1.800.42.555.43 OR VISIT www.hamiltonbeach.in FOR SERVICE CENTER LOCATIONS OR
- KINDLY TAKE THE PRODUCT TO THE PLACE OF PURCHASE OR
- CALL 1.800.42.555.43 FOR SERVICE AT HOME¹

THE PRODUCT OR ANY COMPONENT OF PRODUCT FOUND TO BE DEFECTIVE WILL BE REPAIRED OR REPLACED FREE OF CHARGE DURING THE WARRANTY PERIOD OF 2 YEARS, FROM THE DATE OF PURCHASE. IF THE PRODUCT OR COMPONENT IS NO LONGER AVAILABLE, WE WILL REPLACE WITH A SIMILAR ONE OF EQUAL OR GREATER VALUE.

¹At-home service is limited to certain geographical areas in India; please call 1.800.42.555.43 for further details.

840248201

VALIDITY:

- THIS WARRANTY IS ISSUED SUBJECT TO THE PRODUCTION AND VERIFICATION OF THE ORIGINAL PROOF OF PURCHASE.
- THIS WARRANTY IS VALID IN INDIA ONLY AND IF PRODUCT HAS BEEN PURCHASED FROM AN AUTHORIZED HAMILTON BEACH DEALER.
- THIS WARRANTY DOES NOT COVER GLASS, FILTERS, WEAR FROM NORMAL USE, USE NOT IN CONFORMITY WITH THE PRINTED DIRECTIONS, OR DAMAGE TO THE PRODUCT RESULTING FROM ACCIDENT, ALTERATION, ABUSE, OR MISUSE. THIS WARRANTY ONLY EXTENDS TO THE ORIGINAL CONSUMER PURCHASER OR THE GIFT RECIPIENT.

THE WARRANTY WILL BE CONSIDERED INVALID IF:

- PRODUCT HAS NOT BEEN USED PER THE MANUFACTURER'S OPERATING INSTRUCTIONS.
- PRODUCT HAS BEEN SERVICED, REPAIRED, OPENED, OR TAMPERED WITH BY ANY UNAUTHORIZED PERSON.
- UNAUTHORIZED CORRECTION/ALTERATIONS IN INVOICE COPY/INSTALLATION NOTE/SERIAL NUMBER OF PRODUCT.
- INCOMPLETE WARRANTY CARD AFTER PURCHASE.
- ANY ATTACHMENTS NOT RECOMMENDED BY THE MANUFACTURER HAVE BEEN USED ON THE PRODUCT.
- PRODUCT IS USED FOR OTHER THAN SINGLE-FAMILY HOUSEHOLD USE OR SUBJECT TO ANY VOLTAGE AND WAVEFORM OTHER THAN 220-240V~/ 50Hz.

7/14