

Hamilton Beach®

PROFESSIONAL

Blender

多功能 高速破壁 料理机



Questions?
問題?
www.hamiltonbeach.cn

READ BEFORE USE
使用前阅读

English2
简体中文.....14

IMPORTANT SAFEGUARDS

When using electrical appliances, basic safety precautions should always be followed to reduce the risk of fire, electric shock, and/or injury to persons, including the following:

1. Read all instructions.
2. This appliance is not intended for use by persons (including children) with reduced physical, sensory, or mental capabilities, or lack of experience and knowledge, unless they are closely supervised and instructed concerning use of the appliance by a person responsible for their safety.
3. Close supervision is necessary when any appliance is used by or near children. Children should be supervised to ensure that they do not play with the appliance.
4. To protect against risk of electrical shock, do not put cord, plug, base, or motor in water or other liquid.
5. Unplug cord from outlet when not in use, before putting on or taking off parts, and before cleaning.
6. Avoid contact with moving parts.
7. Do not operate any appliance with a damaged cord or plug, or after the appliance malfunctions, or is dropped or damaged in any manner. All repairs must be conducted by the manufacturer, its service agent, or similarly qualified persons in order to avoid a hazard. Call the provided customer service number.
8. The use of attachments, including canning jars, not recommended or sold by the appliance manufacturer may cause a risk of injury to persons.
9. Do not use outdoors.
10. Do not let cord hang over edge of table or counter or touch hot surfaces, including stove.
11. Do not place on or near a hot gas or electric burner, or in a heated oven.
12. Keep hands and utensils out of the jar and away from the cutting blade, while blending or chopping food, to reduce the risk of severe personal injury and/or damage to the blender or available attachments (attachments may not be provided with blender). A rubber spatula may be used but must be used only when blender is not running.
13. Blades are sharp; handle carefully—especially when emptying or cleaning the blender jar.
14. Do not use a broken, chipped, or cracked blender jar.
15. Do not use broken, cracked, or loose cutting blade assembly.
16. Always operate blender with lid in place. Remove emulsion cup only for adding ingredients or to insert the tamper.
17. When blending hot liquids, secure emulsion cup and close any edge cover opening intended for pouring. To prevent possible burns: Do not exceed the 6-cup (1420-ml) level. Hot liquids may push off lid during blending; therefore, with the protection of an oven mitt or thick towel, place one hand on top of the lid, keep exposed skin away from the lid, and start blending at lowest speed.
18. Ensure cutter assembly is tight and secure to jar. Injury can result if moving blades accidentally become exposed.
19. Do not leave blender unattended while it is operating.
20. Before plugging cord into wall outlet, turn off the appliance. To disconnect cord, switch to OFF (O). Then remove plug from wall outlet.
21. Do not use appliance for other than intended purpose.
22. **CAUTION:** In order to avoid a hazard due to inadvertent resetting of the thermal cut-off, this appliance must not be supplied through an external switching device, such as a timer, or connected to a circuit that is regularly switched on and off by the utility.

SAVE THESE INSTRUCTIONS!

Other Consumer Safety Information

This product is intended for household use only.

The length of the cord used on this appliance was selected to reduce the hazards of becoming tangled in or tripping over a longer cord. If a longer cord is necessary, an approved extension cord may be used. The electrical rating of the extension cord must be equal to or greater than the rating of the appliance. The extension cord must be a grounding-type, 3-wire cord. Care must be taken to arrange the extension cord so that it will not

drape over the countertop or tabletop where it can be pulled on by children or accidentally tripped over.

If the cutting blade assembly locks and will not move, it will damage the motor. Do not use. Call the toll-free customer service number for information.

Do not place blender jar in the freezer filled with food or liquid. This can result in damage to the cutting blade assembly, jar, blender, and possibly result in personal injury.

NOTE: This machine is equipped with motor overload protection. If the motor stops during operation due to overheating, unplug and allow it to cool down for approximately 15 minutes. Plug machine back in to resume normal operation.

Parts and Features

BEFORE FIRST USE: After unpacking the blender, follow the instructions in "Cleaning Your Blender."

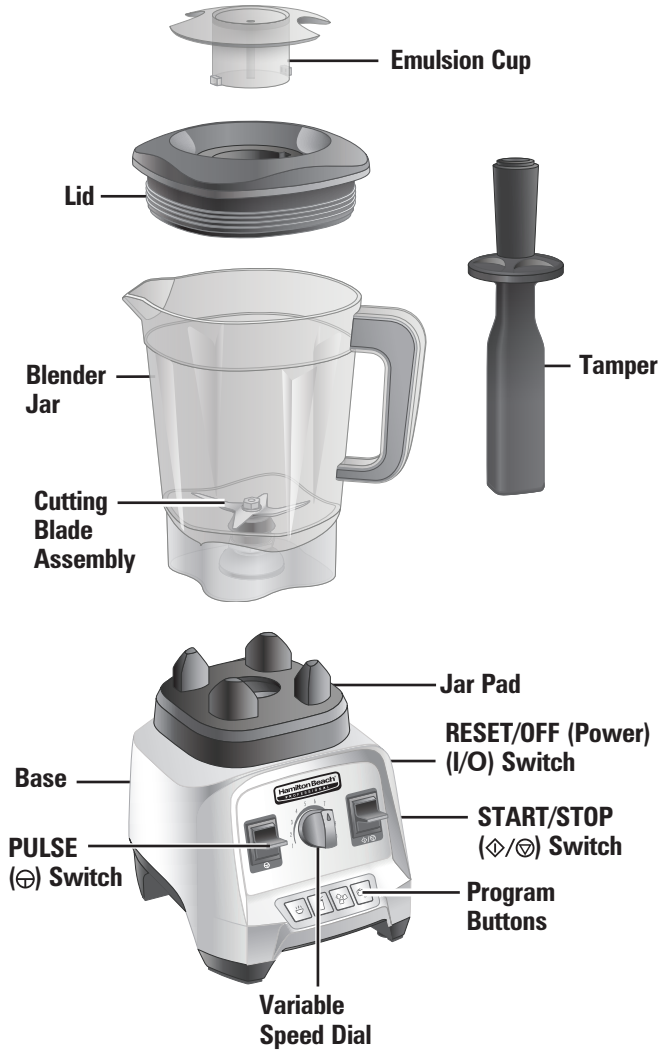

Parts and Features (cont.)

Emulsion Cup: The emulsion cup helps create dressings and sauces that require slowly adding liquid ingredients into the jar while the blender is in operation.

Lid: The lid is easy to put on, take off, and clean. Always use the lid and the emulsion cup when the machine is in operation.

Blender Jar: Volume measures are clearly marked.

Tamper: The tamper helps mix thick or frozen recipes that cannot be processed with regular blending. It prevents air pockets from forming and is a handy tool when making nut butters or frozen desserts.

RESET/OFF (I/O) (Power) Switch/Circuit Breaker:

The RESET/OFF (I/O) (Power) switch is located on the right-hand side of the blender base. This switch controls power to the blender. This switch is also a circuit breaker that, if tripped, must be turned off and back on to reset.

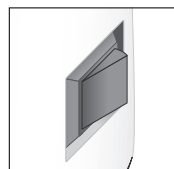

Control Panel



Variable SPEED Dial:

The center VARIABLE SPEED DIAL determines the blender speed setting when blending in MANUAL mode.

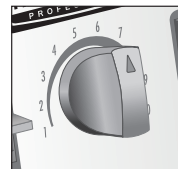

Program Buttons:

There are four program settings: HOT SOUP (☺), SMOOTHIE (☑), ICE CRUSH (☒), and WHOLE JUICE (☒). Select the desired program by pressing the button for that program.

START/STOP (⏏/⏏) Switch:

The START/STOP (⏏/⏏) switch is used to begin or end the MANUAL mode or to stop a program before the cycle ends.



PULSE (⏏) Switch:

Press and hold down the PULSE (⏏) switch to blend at the speed setting shown on the VARIABLE SPEED DIAL in MANUAL mode.



Automatic Overload Protection: This machine is equipped with motor overload protection. If the motor stops during operation due to overheating, unplug and allow it to cool down for approximately 15 minutes. Plug machine back in to resume normal operation.

Using Your Blender

BEFORE FIRST USE: After unpacking the blender, follow the instructions in "Cleaning Your Blender."

IMPORTANT: The blender jar and cutting blade assembly are subject to wear during normal use. Always inspect jar for nicks, chips, or cracks. Always inspect cutting blade assembly for broken, cracked, or loose blades. If jar or cutting blade assembly is damaged, do not use.



Place blender jar on base.



Add ingredients.



Place lid and emulsion cup on jar. Insert the cup into the lid and secure by turning clockwise. Remove the emulsion cup to use the tamper or to add ingredients.

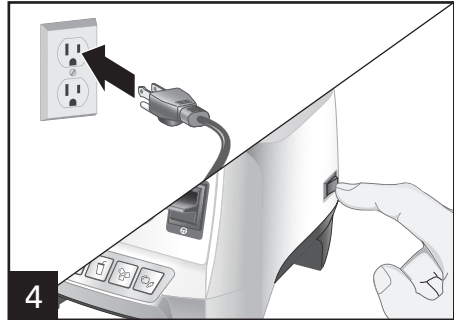

Plug in blender. Move the RESET/OFF (I/O) switch to the RESET (I) position to turn on power to the blender and ready it for blending. The front lights will illuminate. Move the RESET/OFF (I/O) switch to the OFF (O) position anytime the machine is left unattended. If blender is plugged in and switch is in ON (I) position, but panel lights are not illuminated, the blender has entered standby mode. This will happen after 3 minutes of inactivity. Press any control panel button or switch to resume normal operation.

Using Program Settings

Programs are optimized for recipe categories and vary in blending speed and duration. Pressing a program button illuminates only the program selected. The blender automatically starts when the program button is pressed and automatically stops at the end of the program. To stop blender before program cycle ends, press START/STOP (◊/⊖). Pressing the program button again will reset the program, and it will start back from the beginning. Should you press START/STOP (◊/⊖) again, the blender defaults to MANUAL mode.



The **HOT SOUP** (☁) setting purees and heats ingredients to just under the boiling point. Do not blend more than 6 cups (1420 ml) on this program. When making soups, start with cold or room-

temperature ingredients. The emulsion cup can be kept in the lid. Blender runs for 5 minutes, 45 seconds.



The **SMOOTHIE** (🥤) setting blends frozen or fresh smoothies. Blender pulses five times at the beginning to chop ice or frozen ingredients and then ramps up to run on high speed for 45 seconds.



The **ICE CRUSH** (🧊) setting breaks ice into pieces small enough for slushies or fine cocktails. Blender continuously pulses from low to medium for 1 minute.



When a recipe calls for making a fruit or vegetable juice, run the **WHOLE JUICE** (🍏) program. The **WHOLE JUICE** setting gives a smooth consistency to pureed fruit or vegetables and a

fine texture when whole grains or seeds are included in the juice recipe. It is great for blending more fibrous fruits and vegetables into a delicious, healthy juice. The blender slowly ramps up from low to high, running for 55 seconds.

Using Manual Mode



1 Rotate the VARIABLE SPEED DIAL to 1.



2 Press START/STOP (◊/⊙) and slowly rotate the VARIABLE SPEED DIAL to the right or left during blending to increase or decrease blending speed.

If using PULSE (⊖), the blender will run at the speed on the dial only when the PULSE (⊖) switch is held down.



3 – OPTIONAL

⚠ WARNING **Burn Hazard:** Do not fill blender jar with hot liquid beyond the 6-cup (1420-ml) level. With the protection of an oven mitt or thick towel, place one hand on top of lid. Keep exposed skin away from lid. Start blending at lowest speed.

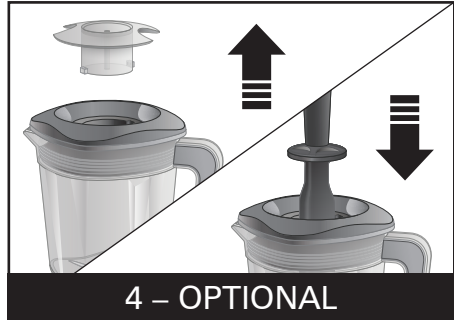

4 – OPTIONAL

Remove emulsion cup and insert tamper into hole in lid. Rotate cup counterclockwise from “locked” to “unlocked” position and lift out. **NOTE:** Turn blender OFF (O) before removing emulsion cup and when adding the tamper.

Using Manual Mode (cont.)



Place one hand on top of lid to move thick mixtures around in blender jar.

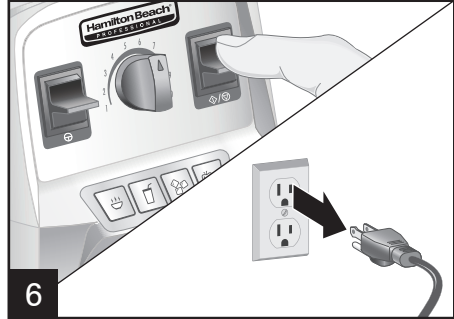

At the end of the blending cycle, rotate the VARIABLE SPEED DIAL back to the 1 position and press the START/STOP (⏻/⏹) switch to stop blending. Turn off the blender with the RESET/OFF (I/O) switch on the right side of the base. Unplug blender after blending.



Remove blender jar.

⚠ WARNING Burn Hazard:



Metal parts under blending jar get hot after extended use.

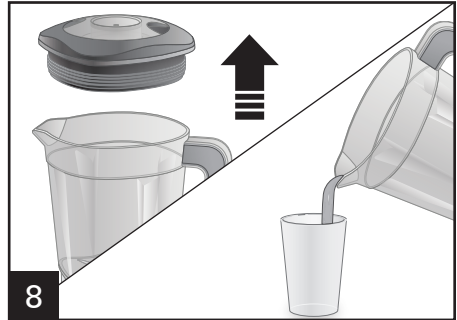

Remove lid by lifting up on any corner while holding blending jar securely. Serve.

Using Your Blender (cont.)

Blender Tips

- To add foods when blender is operating, remove emulsion cup and add ingredients through the opening.
- For best performance, the minimum amount of liquid needed per recipe is one cup (8 ounces/237 ml). Add more liquid if food is not blending properly. The amount of liquid needed will vary based on the other ingredients required for blending.
- If blending action stops during blending or ingredients stick to sides of jar, insert tamper to help move the mixture around or add more liquid to blender jar.
- Do not store food or liquids in blender jar.
- Avoid bumping or dropping blender when in operation or at any time.
- Use tamper when making nut butters and blend in 1-minute intervals.
- Cutting large whole fruits and vegetables may allow them to blend more quickly.
- Do not fill blender jar past highest graduation marking.
- Always place liquid in blender jar first, then remaining ingredients.
- If ice or frozen fruit pieces are not blending, stop the blender and pulse a few times.
- Do not allow ice to stand or freeze in jar. Immediately crush ice after placing in jar.

NOTE: This machine is equipped with motor overload protection. If the motor stops during operation due to overheating, unplug and allow it to cool down for approximately 15 minutes. Plug machine back in to resume normal operation.

Using the Tamper

- The hand protector on the tamper and the lid work together to prevent the tamper from hitting the blades when the lid is secured properly on the blender jar.
- The blender jar should not be more than two-thirds full when the tamper is used during blending.
- Only use the tamper provided with this model blender. Do not use tampers made for any other blender or blender model.
- If food does not circulate, an air bubble may be trapped in the mixture. Remove the blender jar from the blender base. Remove the emulsion cup. Release the air bubble by inserting the tamper through the emulsion cup opening.
- Holding the tamper straight down may not help ingredients circulate. If necessary, point the tamper toward the sides or corners of the blender jar. **DO NOT** try to force the tamper deeper into the jar.

Cleaning Your Blender

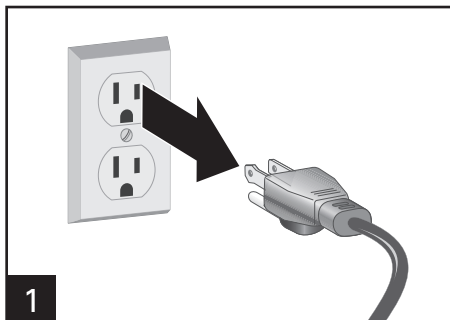

1 Unplug blender.

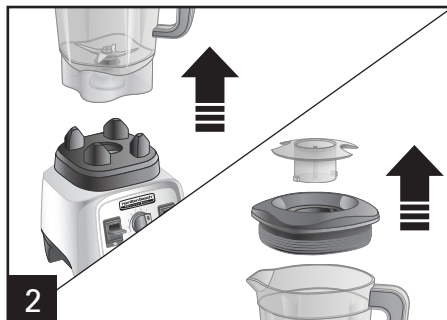

2 Remove jar, lid, and emulsion cup.

⚠ WARNING Electrical Shock Hazard: Disconnect power before cleaning. Do not immerse cord, plug, base, or motor in water or other liquid.

⚠ WARNING Burn Hazard: Metal parts under blending jar get hot after extended use.



3 Wipe blender base, control panel, and cord with a damp cloth or sponge. To remove stubborn spots, use a mild, nonabrasive cleanser.



DISHWASHER-SAFE

DO NOT use the "SANI" setting when washing in the dishwasher. "SANI" cycle temperatures could damage your product. Parts may also be washed with hot, soapy water. Rinse and dry thoroughly. Do not soak.

NOTES:

- **HAND WASH ONLY.** Alternative is to fill jar halfway with water and add 2–3 drops of dish soap. Blend for 30 seconds. Rinse and dry thoroughly.
- To clean after blending oily foods, sprinkle 1/4 cup (59 ml) baking soda in blender. Add 1 cup (237 ml) white vinegar. Mixture will bubble. When bubbling subsides, add 2 cups (473 ml) water and blend on the **HOT SOUP** cycle. Wash any remaining residue with dish soap and water. Rinse and dry thoroughly.

Troubleshooting

Error Messages

PROBLEM

All program buttons are flashing.

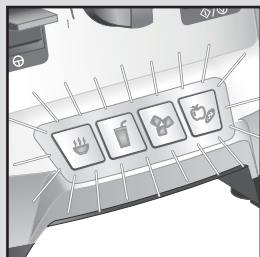

The SMOOTHIE (☑) and ICE CRUSH (☑) buttons are flashing.

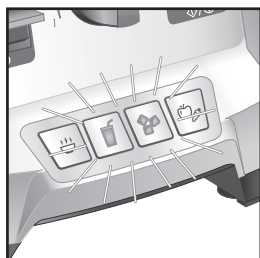

The HOT SOUP (☑) and WHOLE JUICE (☑) buttons are flashing.

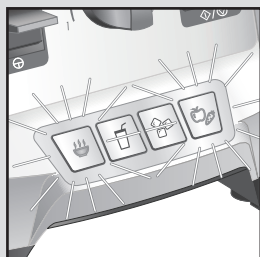

Blender is plugged in and switch is in ON (I) position, but panel lights are not illuminated.

PROBABLE CAUSE/SOLUTION

- The motor has overheated during use. Turn power switch to OFF (O) and allow to cool for 15 minutes. Turn power switch to RESET (I), and resume normal operation.

- Remove the blender jar and lid. Stir contents and top with lid. Press HOT SOUP (☑) cycle. If the problem persists, turn unit off, unplug from electrical outlet, and contact the customer service center.

- The blender speed has ramped up to high too quickly and run on high speed. Turn the unit off, unplug from the electrical outlet, and call the customer service center.

- Blender enters standby mode after 3 minutes of inactivity to conserve power. Press any control panel button or switch to resume normal operation.

NOTE: Buttons start flashing 10 seconds after a problem has occurred.

Troubleshooting (cont.)

PROBLEM	PROBABLE CAUSE/SOLUTION
Blender fails to start and program lights are not illuminated.	<ul style="list-style-type: none"> • Make sure that the main power RESET/OFF (I/O) button is in the RESET (I) position. • Check to see if unit is securely plugged into an electrical outlet of the proper voltage and frequency. • Check to see if the fuse for the electrical outlet has blown or if a circuit breaker has tripped.
Blender stops while it is running and the program lights are illuminated.	<ul style="list-style-type: none"> • This blender is equipped with motor overload protection. If the motor stops during operation due to overheating, unplug and allow the blender to cool down. Plug blender back in after 15 minutes. • Resume normal operation.
Blender stops while running and START/STOP (⏏/⏻) light flashes.	<ul style="list-style-type: none"> • Mixture in blender is too heavy of a load on the motor. This blender is programmed to stop running to protect itself from electrical damage. Remove some of the ingredients from the blender jar. Turn VARIABLE SPEED DIAL to 1 and press the START/STOP (⏏/⏻) switch to continue to process in MANUAL mode. Increase speed as necessary. If this issue happens again, remove more of the blender mixture and start the process again.
Ingredients will not mix properly.	<ul style="list-style-type: none"> • Check to see if enough liquid has been added to the ingredients. Mixture should be fluid and free-running at all times. • Solid pieces are too large. • Container is too full. Do not fill past highest (8 cups/1.9 L) graduation marking. • Cutter assembly blades are not sharp or are damaged. Inspect container and cutter assembly daily. • Select speed to create a fluid blend.
Blender smells like it is burning.	<ul style="list-style-type: none"> • Turn off blender and allow unit to cool. • Although motors are tested during the manufacturing process, heavy use may cause curing of motor windings. The smell may quickly dissipate after a few heavy uses. • If smell continues after additional heavy uses, call our customer care center.
There is grease around the bottom of the blender jar or on the counter top.	<ul style="list-style-type: none"> • Monitor the problem and source. This may indicate an issue with the jar bearings. • Call our customer care center if the condition persists.
Blender jar is cloudy or stained.	<ul style="list-style-type: none"> • Some cloudiness may be natural after use. The minerals from fruits, produce, and leafy greens, in addition to the oils of various nut butters, can sometimes cause a film on the blender jar or may be difficult to clean. • Sprinkle 1/4 cup (59 ml) baking soda in blender. Add 1 cup (237 ml) white vinegar. Mixture will bubble. When bubbling subsides, add 2 cups (473 ml) water and blend on the HOT SOUP (🔥) cycle. Wash any remaining residue with dish soap and water. Rinse and dry thoroughly.
Blender fails to start.	<ul style="list-style-type: none"> • Jar is not in place.

重要安全说明

当使用电器时，应始终遵守基本的安全防范措施，以减少火灾、触电和/或人身伤害的风险，包括以下内容：

1. 阅读所有相关说明。
2. 本电器不适合以下人群（包括儿童）使用：行动不便者、精神或智商缺陷者、缺少经验和常识者，除非他们在监督和指导下使用，以确保安全。
3. 使用或在儿童附近使用该设备时，一定要密切监督。请勿将本电器用于儿童玩耍。
4. 为防止触电危险，请勿将电源线、插头、底座或电机放入水或其他液体中。
5. 当本装置未使用时、安装或拆解部件和清洁该电器前，请从插座拔下电源。
6. 避免接触正在运动的部件。
7. 在下列情况下，请勿使用设备：电源线或插头破损、设备出现故障、设备曾跌落或已经出现任何形式的损坏。所有维修必须由制造商、维修代理商或同等资质的人员进行，以避免险情。请致电所提供的客户服务电话。如果电源软线损坏，为了避免危险，必须由制造商、其维修部或类似部门的专业人员更换。
8. 使用非由电器制造商建议或出售的包括搅拌杯在内的附件，可能导致人身伤害。
9. 请勿户外使用。
10. 请勿将电源线搭置在桌台边缘上或与发热表面接触，包括炉子。
11. 请勿将电器放置在高温气体或电炉之上或附近，或放置在加热的烤箱内。
12. 在搅拌或切碎食物时，手和器具请勿置于搅拌杯中，并且要远离切割刀片，以降低严重人身伤害或配件损坏（本料理机可能未配备这些配件）风险。可使用橡胶刮铲，但仅限于在料理机未运行时使用。
13. 刀片很锋利；排空搅拌杯和清洗时，务必要小心处理。
14. 请勿使用有任何裂口或裂缝的搅拌杯。
15. 请勿使用有裂口、裂痕或松动的切割刀片组件。
16. 本机仅在提供的底座上使用，务必在搅拌杯盖好盖子以后才操作料理机。仅在添加食材或插入搅拌棒时才能取下加料口盖。
17. 搅拌热液体时，盖紧加料口盖并关闭任何用于倒出的边盖口。为防止可能的烫伤：请勿超过搅拌杯的6杯（1420毫升）液位。搅拌过程中热液体可能会将盖子推出；因此，应戴上烤箱手套或用厚毛巾进行保护，用戴手套的手压住盖子的顶部，保持裸露的皮肤远离盖子，然后开始以最低速度搅拌。
18. 确保搅拌杯底座的刀片组件安装牢固。如果转动刀片意外暴露，则可能导致受伤。
19. 请勿让搅拌机在无人看管的情况下运行。在更换附件或接触运动部件前要关掉电源开关并断开电源。
20. 在将电源线插入壁装电源插座前，请关闭设备。拔掉电源线插头前，请将开关转到OFF（O）位置。然后从壁装电源插座上拔下插头。
21. 请勿将该装置用于非预期用途。
22. **小心：**为了避免由于热熔断路器的意外重置导致的危险，本电器不能在外接定时器或独立的遥控控制系统的方式下运行。

请妥善保管这些说明！

其他用户安全信息

本产品建议于家庭使用。

此电器电源线的长度经过设计挑选，以减少长电源线缠绕或绊倒的危险。倘若需要更长的电源线，可使用有认证的电源延长线。电源延长线的额定功率必须等于或大于此电器的额定功率。电源延长线必须为接地型的3线电源线。电源延长线使用时需特别注意，以防将其搭设在工作台或桌台上，造成儿童扯拉或绊倒他人。

如果切割刀片组件锁住而不能移动，可能会损坏电机。请勿使用。要了解有关信息，请拨打免费售后服务电话。

请勿将装有食物或液体的搅拌杯放入冰箱中。这可能导致切割刀片组件、搅拌杯、搅拌机损坏及可能的人身伤害。

注意：本机配有电机过热保护。在操作期间如果电机因过热而停止，请拔掉电源插头并让机器冷却15分钟。然后再插上机器的电源插头以恢复正常操作。

部件和功能

首次使用前：拆开多功能高速破壁料理机的包装后，请遵循“清洁您的料理机”中的说明。



部件和功能 (续)

加料口盖: 制作调料和酱汁时, 在料理机运行过程中, 可使用加料口盖慢慢地将液体成分加入到料理机中。

盖子: 盖子的设计便于盖上、拿下及清理。在操作电器时, 务必使用盖子和加料口盖。

搅拌杯: 清楚标示有计量单位。

搅拌棒: 搅拌棒有助于混合不适用普通搅拌功能搅拌的浓稠或冷冻材料的食物。它可防止气泡形成, 为果仁酱或冷冻甜点制作的好帮手。

重置/关闭 (I/O) (电源) 开关/断路器:

重置/关闭 (I/O) (电源) 开关位于搅拌杯底座的右侧。此开关控制料理机的电源。此开关也用作断路器使用, 如果跳闸将关闭机器, 复位后重置。

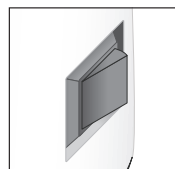

控制面板



变速旋钮:

中间的变速旋钮决定料理机在手动模式时的速度设定。

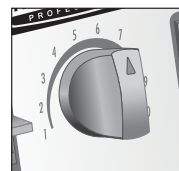

程序按钮:

有四种程序设置: 热汤 (☺)、冰沙 (☽)、刨冰 (☼) 和纯果汁 (☹)。按对应的按钮选择所需的程序。

启动/停止 (⏻/⏺) 开关:

启动/停止 (⏻/⏺) 开关用于开始或停止手动模式, 或在某一程序结束前停止该程序。



脉冲 (⏻) 开关:

按住脉冲 (⏻) 开关不放, 以手动模式中变速旋钮上所设定的速度进行搅拌。



自动过热保护: 本机配有电机过热保护。在操作期间如果电机因过热而停止, 请拔掉电源插头并让机器冷却15分钟。然后再插上机器的电源插头以恢复正常操作。

使用您的料理机

首次使用前：拆开多功能高速破壁料理机的包装后，请遵循“清洁您的料理机”中的说明。

重要提示：您的搅拌杯和切割刀片组件在正常使用过程中可能会磨损。请务必检查搅拌杯是否有裂纹、缺口或裂缝。请务必检查切割刀片组件是否有破损、破裂或松动。如果搅拌杯或切割刀片组件损坏，请勿使用。



将搅拌杯放置到底座上。



添加食材。



盖上搅拌杯盖子和加料口盖。将加料口盖插入到搅拌杯盖中并顺时针旋转固定。取下加料口盖，以使用搅拌棒或添加食材。

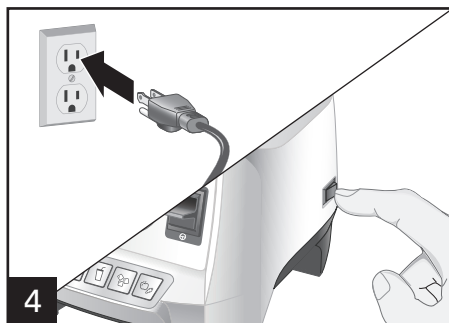

插上料理机插头。将重置/关闭 (I/O) 开关调到重置 (I) 位置开启料理机，并准备进行搅拌。正面的指示灯点亮。在机器处于无人看管状态时，将重置/关闭 (I/O) 开关调到关闭 (O) 位置。如果料理机已经插上电源并且开关位于开启 (I) 位置，但面板指示灯不点亮，表明料理机已进入待机模式。3分钟内无任何操作将出现这种情况。按控制面板上的任意按钮或旋转开关以恢复正常操作。

使用程序设置

程序将各种不同搅拌速度和持续时间的配方进行优化。按下一个程序按钮仅所选程序指示灯点亮。当按下程序按钮后，料理机自动开始工作，程序结束后，料理机自动停止工作。要在程序循环前停止料理机，请按启动/停止（◊/⊗）按钮。再次按程序按钮，将会重置程序，程序将从头开始执行。如果您再次按启动/停止（◊/⊗）按钮，料理机将默认为手动模式运行。



热汤 (🍲)

设置可制作浓汤，并将浓汤加热至接近沸点的温度。此程序搅拌量不得超过6杯（1420毫升）。制作汤时，食材请从低温或室温开始搅拌。加料口盖可以保持在盖子上。料理机运行5分45秒。

料理机运行5分45秒。



冰沙 (🍹)

设置搅拌冰冻或新鲜冰沙。料理机首先脉冲运行五次，将冰或冰冻原料削碎，然后转换为高速运行45秒。



刨冰 (🍧)

设置将冰块粉碎，用于制作糖浆饮料或精美鸡尾酒。料理机从低脉冲执行至中脉冲，时长为1分钟。



如果食谱需要制作果汁或蔬菜汁，请运行纯果汁（🍏）程序。纯果汁设置可实现对水果泥或蔬菜泥的均匀搅拌，将全谷物或种籽加入果汁后，会令成品看起来十分精细。多纤维水果及蔬菜因此得以打成美味健康的果蔬汁。料理机从低到高慢慢加速，运行55秒。

料理机从低到高慢慢加速，运行55秒。

使用手动模式



1 旋转变速旋钮到位置1。



2 按启动/停止 (⚡/⏻) 按钮，在搅拌期间慢慢向左或向右旋转变速旋钮增加或降低搅拌速度。

如果使用脉冲 (⊖) 开关，仅在按下脉冲 (⊖) 开关时，料理机才会将以旋钮上所指示的速度运行。



3 - 可选

警告 烫伤危险：倒入搅拌杯中的热水量不得超过6杯（1420毫升）刻度线。戴上烤箱手套或用厚毛巾进行保护，用戴手套的手压住盖子的顶部。让暴露的皮肤远离盖子。以最低速度开始搅拌。

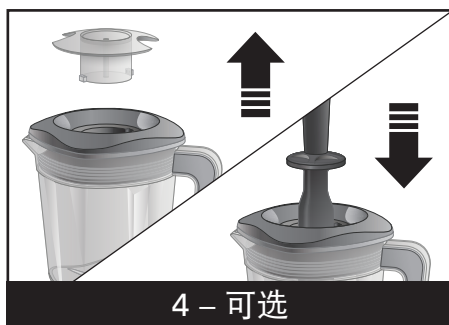

4 - 可选

取下加料口盖并把搅拌棒插入盖孔中。将加料口盖从上锁位置逆时针旋转至解锁位置并将其提出。

注意：取下加料口盖并插入搅拌棒前，请将料理机开关调整到关闭 (O) 位置。

使用手动模式 (续)



5 请将一只手压住盖子，使用搅拌棒将旁边浓稠混合物推进搅拌杯内。

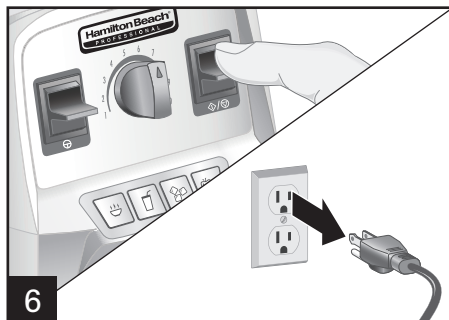

6 在搅拌周期结束时，旋转变速旋钮至1位置，并按启动/停止 (⏻/⏹) 开关以停止搅拌操作。使用底座右侧的重置/关闭 (I/O) 开关关闭料理机。搅拌后拔掉料理机的电源插头。



7 取下搅拌杯。

烫伤危险：



长时间使用料理机后，其杯下的金属部分会发烫。

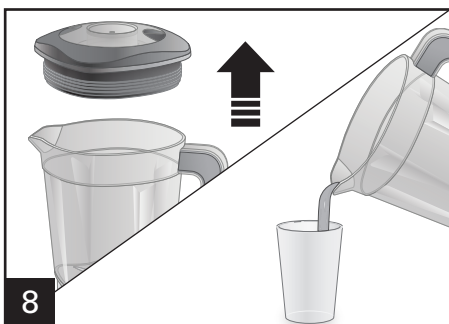

8 握紧搅拌杯的同时上提任一角，以此拆下盖子。倒出饮用。

使用您的料理机 (续)

料理机小贴士

- 若要在料理机运行时加入食物，请从盖子上取下加料口盖，并通过开口加入食材。
- 为获得最佳性能，每种食谱至少需要一杯液体（8 盎司/237 毫升）。如果食物未正确混合，请加入更多液体。根据搅拌的食材，所需的液体量可能有所不同。
- 如果搅拌过程中搅拌操作停止或食材粘在搅拌杯侧面，插入搅拌棒搅动边上的食物或向搅拌杯中再添加液体。
- 请勿将食物或液体储存在搅拌杯中。
- 避免在运行过程中或在任何时间碰撞料理机或使其跌落。
- 制作果仁酱时，请使用搅拌棒并且按1分钟间隔间进行搅拌。
- 大型水果蔬菜的切割可能加快它们的搅拌速度。
- 加入到搅拌杯中的食材量不得超过最高刻度标记。
- 务必先将液体倒入搅拌杯中，然后加入其他食材。
- 如果未成功搅拌冰冻水果，请停止料理机运作，先脉冲几次。
- 请勿让冰块在搅拌杯中存留或结冰。冰块放入搅拌杯后，请即刻粉碎。

注意：本机配有电机过热保护。在操作期间如果电机因过热而停止，请拔掉电源插头并让机器冷却15分钟。然后再插上机器的电源插头以恢复正常操作。

使用搅拌棒

- 当盖子正确固定到搅拌杯上时，搅拌棒需配合盖子一起操作，以防搅拌棒碰撞刀片。
- 在搅拌过程中使用搅拌棒时，加入搅拌杯的食材不得超过搅拌杯的三分之二。
- 仅能使用由本型号料理机提供的搅拌棒。请勿使用其他料理机或其他料理机型号专用的搅拌棒。
- 如果食物不流通，混合物中将可能出现气泡。将搅拌杯从底座中移除。拆下加料口盖。将搅拌棒插入加料口盖空隙中以排出气泡。
- 垂直按下搅拌棒不能协助食材流通。如有必要，请将搅拌棒对着搅拌杯的侧面或角落。请勿尝试强制性地让搅拌棒进入搅拌杯的更深处。

清洁您的料理机

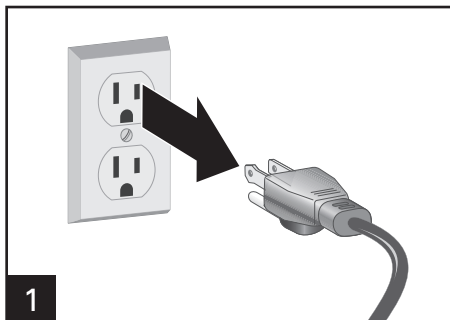

1 拔掉料理机电源插头。

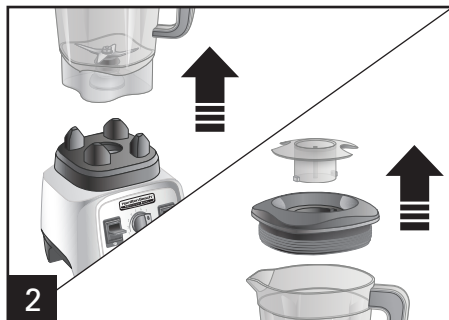

2 拆下搅拌棒、盖子和加料口盖。

警告 电击危险：

清洁前断开电源。请勿将电源线、插头、底座或电机浸入水或其他液体中。

警告 烫伤危险：

长时间使用料理机后，其杯下的金属部分会发烫。



3 用湿布或海绵擦拭料理机底座、控制面板和电源线。若要去除顽固的斑点，请使用温和的防磨损清洁剂。

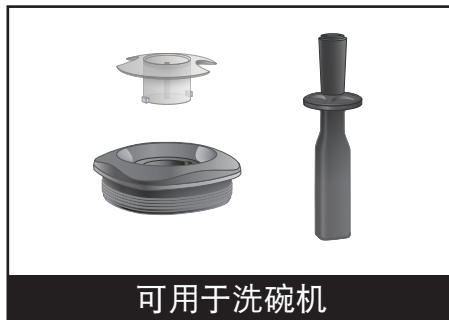

可用于洗碗机

在洗碗机中清洗时，请勿使用“SANI”设置。“SANI”循环温度会损坏本产品。部件也可以在带清洁剂的温水中清洗。彻底冲洗后擦干。请勿浸泡。

注意：

- 仅能手洗。或者可以在搅拌杯中注入一半的水，然后添加2至3滴洗洁精。搅拌30秒钟。彻底冲洗后擦干。
- 要在搅拌了油性食物后进行清洗，在搅拌机上洒1/4杯（59毫升）小苏打。加1杯（237毫升）白醋。混合物将会起泡。泡沫消退后，加2杯（473毫升）水，使用热汤程序搅拌。用洗洁精和清水冲洗掉所有的残余液体。彻底冲洗后擦干。

故障排除

错误信息

问题

所有程序按钮在闪烁。

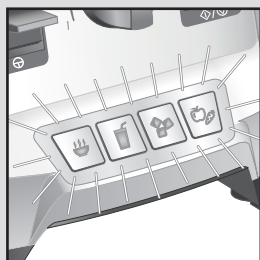

冰沙 (☞) 和刨冰 (☞) 按钮一直闪烁。

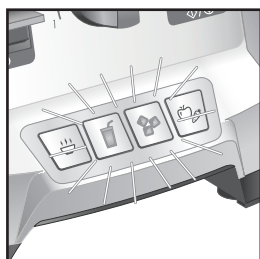

热汤 (☞) 和纯果汁 (☞) 按钮一直闪烁。

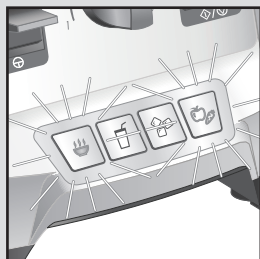

料理机电源已插上且开关处于开启 (I) 位置，但是面板指示灯不亮。

可能的原因/解决方案

- 使用过程中，电机温度过高。请将电源开关调至关 (O) 位置上，冷却15分钟。将开关调至重置 (I) 位置，复原正常操作。
- 拆下搅拌杯和盖子。手动搅拌食物，然后盖上盖子。按热汤 (☞) 程序。如果问题仍未解决，请关闭电源，拔掉电源插头，并联络客户服务中心。
- 料理机速度上升过快，料理机高速运作。请关闭电源，拔掉电源插头，并联络客户服务中心。
- 无任何操作超过3分钟，料理机进入待机模式以节省电能。按控制面板上的任意按钮或旋转开关以恢复正常操作。

注意：问题出现后10秒钟，按钮开始闪烁。

故障排除 (续)

问题	可能的原因/解决方案
料理机启动失败且程序指示灯不亮。	<ul style="list-style-type: none">• 确保主电源的重置/关闭 (I/O) 按钮位于重置 (I) 位置。• 检查插头是否安全插入电源插座中；电源电压、频率是否正确。• 检查电源插座的保险丝是否熔断，或电源开关是否切断。
料理机在运行过程中停止且程序指示灯点亮。	<ul style="list-style-type: none">• 此款料理机具备电机过热保护功能。在操作期间如果电机因过热而停止，请拔出插头，让料理机冷却。15分钟后，重新插上料理机插头。• 恢复正常操作。
料理机在运行过程中停止且启动/停止 (◇/⊙) 指示灯闪烁。	<ul style="list-style-type: none">• 料理机里的料理物过重，超出电机负载量。此款料理机能自动停止运作以避免发生电力事故。将一部分食材移出搅拌杯。将变速旋钮旋转至1并按启动/停止 (◇/⊙) 开关继续以手动模式运行。必要时增高速度。如果再次出现此问题，请继续移出部分搅拌物，随后重启程序。
食材搅拌不均匀。	<ul style="list-style-type: none">• 检查食材中是否添加了足够量的液体。应保证混合物为流质且能随时自由运行。• 固体块过大。• 容器过满。请勿超过最高刻度标记（8杯/1.9升）。• 切割刀具组件不锋利或已磨损。每日检查容器和切割组件。• 选择合适液体混合物的搅拌速度。
料理机有焦味。	<ul style="list-style-type: none">• 关闭料理机，让本机冷却。• 虽然在制造过程中对电机进行了测试，但是大量使用可能会导致电机绕组固化。频繁使用几次后，此味道迅速消失。• 如果多次频繁使用后仍有此味道，请致电我们的客户服务中心。
搅拌杯底部或台面上有油脂。	<ul style="list-style-type: none">• 查找问题和来源。这可能是搅拌杯轴承相关的问题。• 如果情况持续，请致电我们的客户服务中心。
搅拌杯颜色暗沉或污迹斑斑。	<ul style="list-style-type: none">• 使用后可能会出现一些颜色暗沉，属正常现象。除了各种果仁酱里的油外，水果、农作物及绿色蔬菜中的矿物质有时可在搅拌杯中形成一层薄膜，或者可能难以清洗。• 在料理机内喷洒1/4杯（59毫升）食用苏打水。加1杯（237毫升）白醋。混合物将会起泡。泡沫消退后，加2杯（473毫升）水，使用热汤 (☺) 程序搅拌。用洗洁精和清水冲洗掉所有的残余液体。彻底冲洗后擦干。
料理机启动失败。	<ul style="list-style-type: none">• 搅拌杯位置摆放不当。

Model/型号:	Type/类别:	Capacity/容积:	Rating/规格:
58911-CN	B79	1800毫升	220V, 50Hz, 1400W
58912-CN			

Dist.: Hamilton Beach Brands, Inc., Glen Allen, VA 23060
© 2015 Hamilton Beach Brands, Inc.

以上内容如有改动，恕不预先通知



添加官方微博 微信
开启美食人生

840257200